

The power of Infini8



Technical features

'Ashta' or Eight is a powerful number; it represents infinity. The two circles that form an '8' have no beginning or end; they merge into one infinite unit. TechnoSLAB has a distinct character propelled with eight powers. We call it the Power of Infini8.



UV & HEAT
RESISTANT

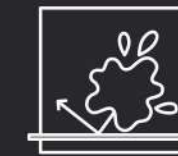

STAIN
RESISTANT



SCRATCH &
ABRASION
RESISTANT



WATER
RESISTANT



CHEMICAL
RESISTANT



HYGIENIC
SURFACE

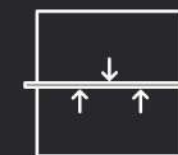

DIMENSIONAL
STABILITY



FROST
RESISTANT

Explore the unexplored



02.1 Marble Series

Discover a spree of color sprinkled on white marble slabs as you go deep diving for your best match into the Marble series.



Living room

From casual conversation to entertainment, the living room is where memories are made. Elegance and sophistication in your space that reflects your style.

Wall

Blackgold Travertine

2400x1200mm
Lustrous

✂ 9 mm Thickness

Floor

Antique Botticino

2400x1200mm
Lustrous

✂ 9 mm Thickness

Dining Table

Timber Bruno

2400x1200mm
Mute

✂ 6 mm Thickness

Steps

Blackgold Travertine

2400x1200mm
Lustrous

✂ 9 mm Thickness

Riser

Antique Botticino

2400x1200mm
Lustrous

✂ 9 mm Thickness





Marble series

Antique Botticino

2400x1200mm

Lustrous

✂ 9 mm Thickness

Total faces - 2



1200x1200mm
Lustrous
9 mm
4 Faces



Marble series

Blackgold Travertine

2400x1200mm

Lustrous / Orgatech

✂ 9 mm Thickness

Total faces - 2



Leisure Area

Nothing like a breath of fresh air and cup of tea in your leisure time is the simplest way of bringing your space to life. From the marble series giving rich feel of Natural Stone available in earthy natural hues.



Wall

Armani Grey

2400x1200mm
Crystalline

✦ 9 mm Thickness

Artistic Wall

Armani Gold

1200x1200mm
Crystalline

✦ 9 mm Thickness

Floor

Armani Gold

1200x1200mm
Lustrous

✦ 9 mm Thickness





Marble series

Armani Grey

2400x1200mm

Lustrous / Crystalline / Satin

✂ 9 mm Thickness

Total faces - 3



Color Options

Armani Gold

Armani Brown

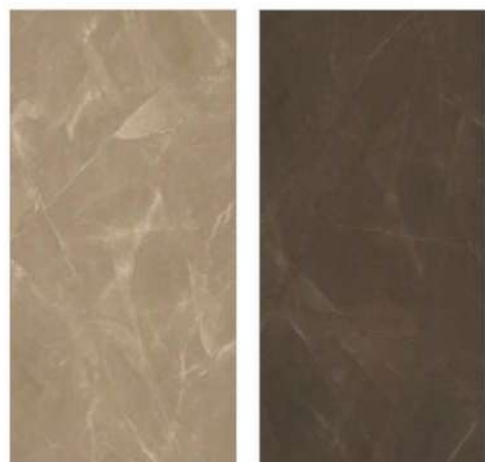

2400x1200mm
1200x1200mm
Lustrous / Satin
9 mm
3 Faces

2400x1200mm
1200x1200mm
Lustrous
9 mm
3 Faces



1200x1200mm
Lustrous / Satin
9 mm
5 Faces



Marble series

Camouflage Esperada

2400x1200mm

Lustrous

✂ 9 mm Thickness

Total faces - 3





Marble series

Antique Grey

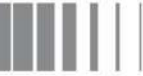

3200x1600mm

Crystalline

✂ 9 mm Thickness

Total faces - 3

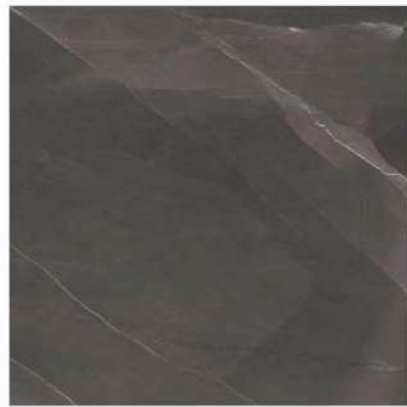
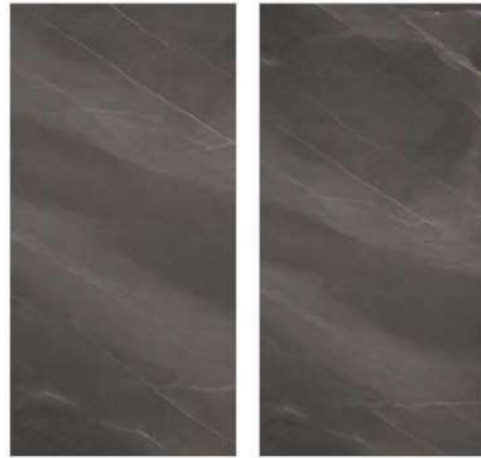

1600x1600mm
Crystalline
9 mm
5 Faces



Marble series

Statuario Unico



3200x1600mm

Crystalline / Satin

✂ 6 mm Thickness

✂ 9 mm Thickness

✂ 12 mm Thickness

Total faces - 3

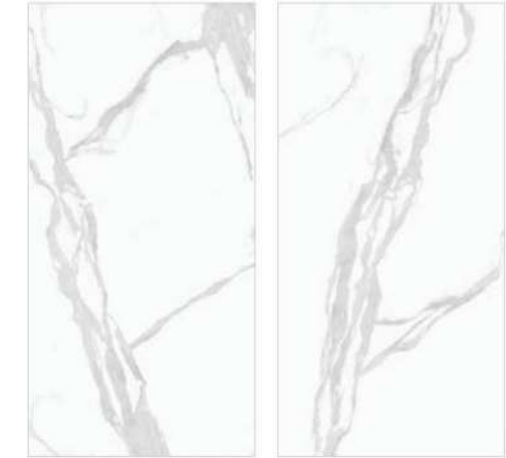

2400x1200mm
Lustrous / Crystalline /
Satin
6 mm, 9 mm
3 Faces



1600x1600mm
Crystalline / Satin
9 mm
6 Faces

02.1 Marble series



Marble series

Carrara Ultimo

3200x1600mm



Marble series

Carrara

3200x1600mm

Waiting Area

The wait can't get any longer. Fascinating and elegant tile options can create a huge swathe effect to your waiting area.

Wall - 1

Carrara Ultimo

2400x1200mm
Crystalline

✂ 6 mm Thickness

Wall - 2

Carrara Ultimo

2400x1200mm
Crystalline

✂ 6 mm Thickness

Wall - 3

Astonia Grey

2400x1200mm
Crystalline

✂ 9 mm Thickness

Steps

Astonia Grey

2400x1200mm
Crystalline

✂ 9 mm Thickness

Floor

Carrara Ultimo

2400x1200mm
Crystalline

✂ 9 mm Thickness





Marble series

Carrara Ultimo



3200x1600mm

Crystalline / Satin

- ✕ 6 mm Thickness
- ✕ 9 mm Thickness
- ✕ 12 mm Thickness

Total faces - 3



2400x1200mm
Lustrous / Crystalline
6 mm, 9 mm
3 Faces

1600x1600mm
Crystalline
9 mm
6 Faces



Marble series

Carrara



3200x1600mm

Crystalline / Satin

- ✕ 6 mm Thickness
- ✕ 9 mm Thickness
- ✕ 12 mm Thickness

Total faces - 2



2400x1200mm
Lustrous / Crystalline /
Satin
6 mm, 9 mm
2 Faces

1600x1600mm
Crystalline
9 mm
4 Faces

Marble series

Everest White

3200x1600mm

Crystalline / Satin

- ✕ 6 mm Thickness
- ✕ 9 mm Thickness
- ✕ 12 mm Thickness

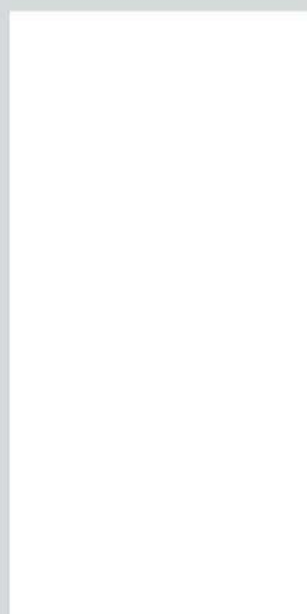
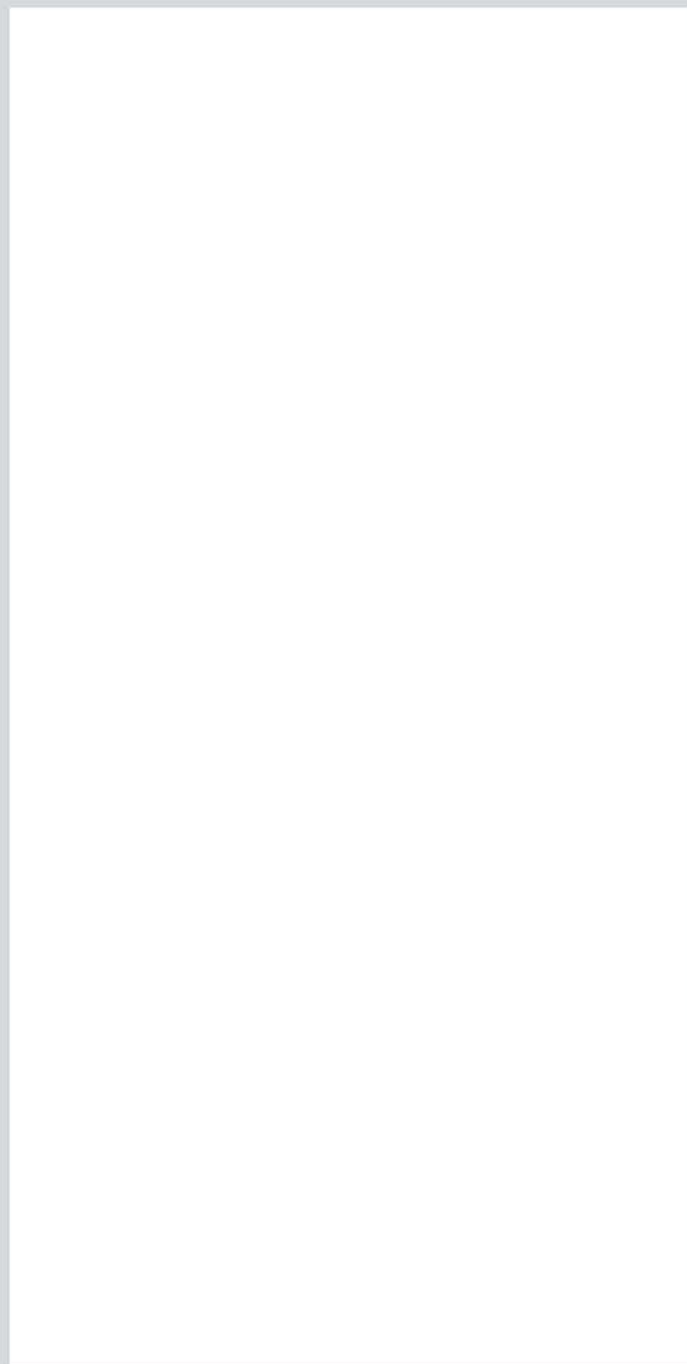

2400x1200mm
Lustrous / Satin
6 mm, 9 mm, 12 mm

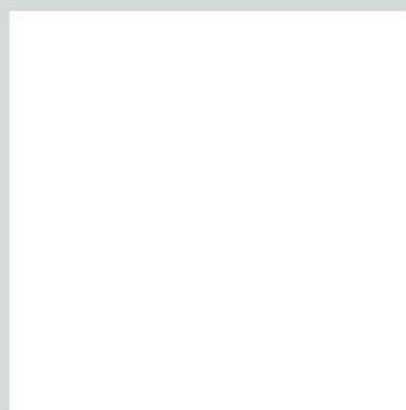

1600x1600mm
Crystalline / Satin
9 mm



1200x1200mm
Lustrous / Mute
9 mm

Marble series

Bianco Lasa

3200x1600mm

Crystalline / Satin

- ✕ 6 mm Thickness
- ✕ 9 mm Thickness
- ✕ 12 mm Thickness



Total faces - 3



2400x1200mm
Lustrous
9 mm
3 Faces

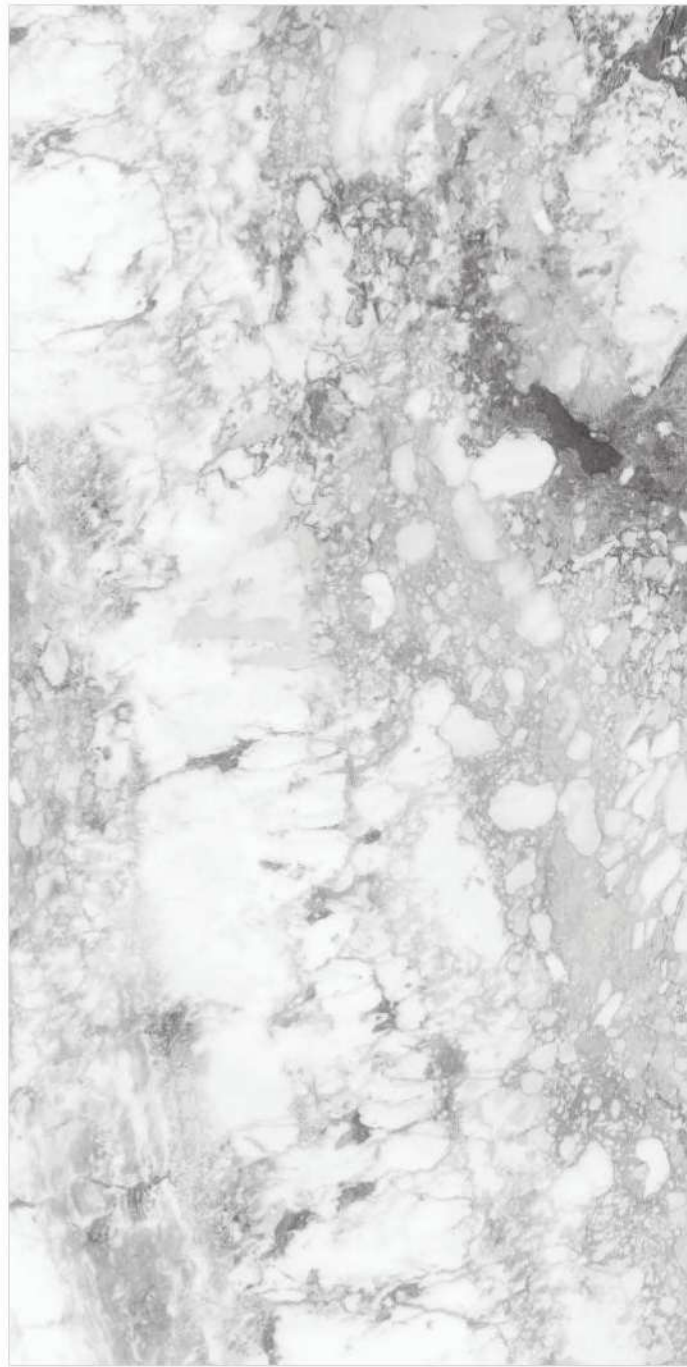

Marble series

Arabescato Statuario

2400x1200mm

Lustrous / Crystalline

✂ 9 mm Thickness

Total faces - 3

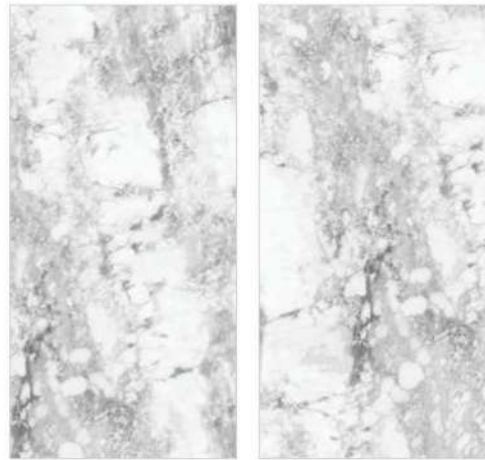

Marble series

Statuario Bianco

2400x1200mm

Lustrous / Crystalline

✂ 9 mm Thickness

Total faces - 4



1200x1200mm
Lustrous
9 mm
8 Faces

02.1 Marble series



Marble series

Statuario



3200x1600mm

Crystalline

- ✂ 6 mm Thickness
- ✂ 9 mm Thickness
- ✂ 12 mm Thickness

Total faces - 3

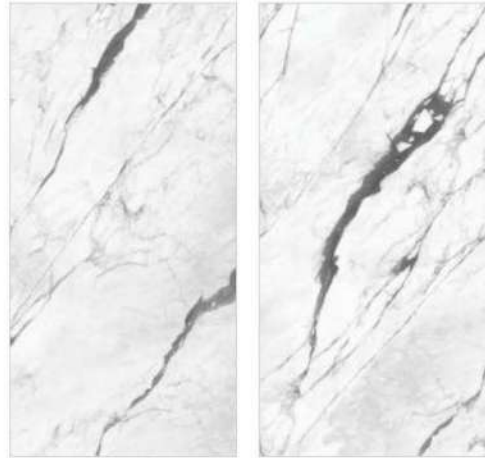

2400x1200mm
Lustrous
9 mm
3 Faces

1600x1600mm
Crystalline
9 mm
6 Faces



Marble series

Apuane Statuario



3200x1600mm

Crystalline / Satin

- ✂ 6 mm Thickness
- ✂ 9 mm Thickness
- ✂ 12 mm Thickness

Total faces - 2



2400x1200mm
Lustrous / Crystalline /
Satin
6 mm, 9 mm
2 Faces

1600x1600mm
Crystalline
9 mm
4 Faces

1200x1200mm
Lustrous
9 mm
4 Faces

02.1 Marble series



Marble series

Calacutta Borghini

3200x1600mm

Crystalline / Satin

- ✕ 6 mm Thickness
- ✕ 9 mm Thickness
- ✕ 12 mm Thickness

Total faces - 3



2400x1200mm
Lustrous / Crystalline /
Satin
6 mm, 9 mm 12 mm
3 Faces



1600x1600mm
Crystalline
9 mm
6 Faces



Marble series

Statuario Platina

3200x1600mm

Crystalline / Satin

- ✕ 6 mm Thickness
- ✕ 9 mm Thickness
- ✕ 12 mm Thickness

Total faces - 3

Continue Faces



2400x1200mm
Lustrous / Crystalline /
Satin
6 mm, 9 mm
3 Faces



1200x1200mm
Lustrous / Satin
9 mm
6 Faces



Marble series

Statuario Venato

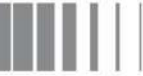

3200x1600mm

Crystalline / Satin

- ✕ 6 mm Thickness
- ✕ 9 mm Thickness
- ✕ 12 mm Thickness

Total faces - 2

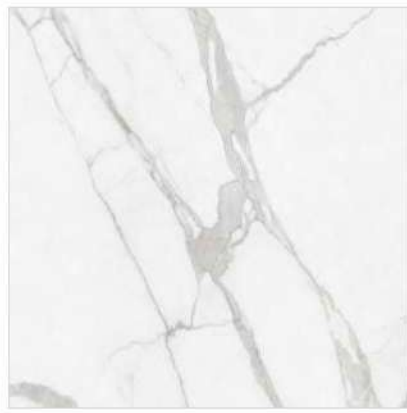

1600x1600mm
Crystalline
9 mm
4 Faces



Marble series

Statuario Venetian



2400x1200mm

Lustrous / Crystalline / Satin

- ✕ 6 mm Thickness
- ✕ 9 mm Thickness

Total faces - 5

Continue Faces



1200x1200mm
Lustrous / Satin
9 mm
6 Faces



Luxurious Bathroom

Tiles that spell splendour for the enigmatic and enormous commercial bathroom area. The aesthetic designs make a mark for their own.

Wall - 1

Silver River

2400x1200mm
Lustrous

✂ 9 mm Thickness

Wall - 2

Calacutta Bianco Oro

2400x1200mm
Crystalline

✂ 9 mm Thickness

Wall - 3

Calacutta Bianco Oro

2400x1200mm
Crystalline

✂ 9 mm Thickness

Floor

Silver River

2400x1200mm
Lustrous

✂ 9 mm Thickness

Bathtub

Calacutta Bianco Oro

2400x1200mm
Lustrous

✂ 9 mm Thickness



Marble series

Calacutta Bianco Oro

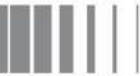

3200x1600mm

Crystalline

- ✂ 6 mm Thickness
- ✂ 9 mm Thickness
- ✂ 12 mm Thickness

Total faces - 3



2400x1200mm
Lustrous / Crystalline
9 mm
3 Faces



1600x1600mm
Crystalline
9 mm
5 Faces



Marble series

Celio



3200x1600mm

Crystalline

- ✂ 9 mm Thickness
- ✂ 12 mm Thickness

Total faces - 2



1600x1600mm
Crystalline
9 mm
6 Faces



Marble series

Botticino Fiorito



2400x1200mm

Lustrous

✂ 9 mm Thickness

Total faces - 2



1200x1200mm
Lustrous
9 mm
4 Faces



Marble series

Bronze Armani



3200x1600mm

Crystalline / Satin

✂ 9 mm Thickness

✂ 12 mm Thickness

Total faces - 3



1600x1600mm
Crystalline
9 mm
5 Faces

O2.1 Marble series



Marble series

Breccia



3200x1600mm

Crystalline

✂ 9 mm Thickness

Total faces - 4



Marble series

Breccia Nuvo



2400x1200mm

Lustrous

✂ 9 mm Thickness

Total faces - 2



2400x1200mm
Lustrous
9 mm
4 Faces

1600x1600mm
Crystalline
9 mm
4 Faces

1200x1200mm
Lustrous
9 mm
4 Faces

1200x1200mm
Lustrous / Satin
9 mm
4 Faces



Marble series

Breccia Blue



2400x1200mm

Lustrous

✂ 9 mm Thickness

Total faces - 2



Marble series

Dolce Grey



2400x1200mm

Lustrous

✂ 9 mm Thickness

Total faces - 2





Marble series

Classic Beige



3200x1600mm

Crystalline

✂ 9 mm Thickness

Total faces - 3

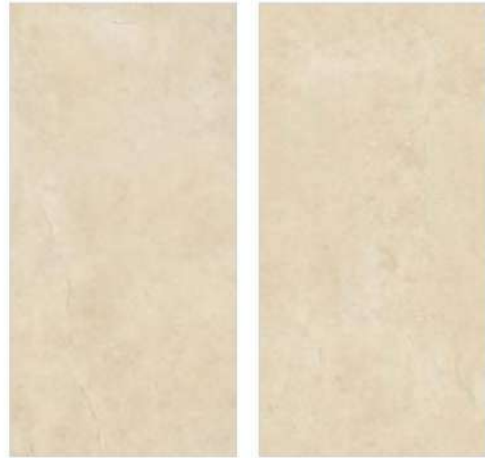

2400x1200mm
Lustrous
9 mm
3 Faces



1600x1600mm
Crystalline
9 mm
6 Faces



1200x1200mm
Lustrous
9 mm
6 Faces



Marble series

Burberry Beige



3200x1600mm

Crystalline

✂ 9 mm Thickness

Total faces - 2



2400x1200mm
Lustrous / Crystalline
9 mm
2 Faces



1600x1600mm
Crystalline
9 mm
4 Faces



Marble series

Omani

2400x1200mm

Lustrous

✂ 9 mm Thickness

Total faces - 4



1200x1200mm
Lustrous
9 mm
6 Faces



Marble series

Regal Beige

2400x1200mm

Lustrous / Crystalline

✂ 9 mm Thickness

Total faces - 2



1200x1200mm
Lustrous
9 mm
6 Faces

O2.1 Marble series

Bathroom

The residential bathrooms space can be crafted with our massive tile collection creating an incredibly calming effect.

Wall - 1

Emperador Classic

1200x1200mm
Lustrous

✂ 9 mm Thickness

Wall - 2

Emperador Light

1200x1200mm
Lustrous

✂ 9 mm Thickness

Floor

Emperador Light

1200x1200mm
Lustrous

✂ 9 mm Thickness

Basin Table

Emperador Light

1200x1200mm
Lustrous

✂ 9 mm Thickness



Marble series

Emperador Light



2400x1200mm

Lustrous

✂ 9 mm Thickness

Total faces - 4



1200x1200mm
Lustrous
9 mm
4 Faces



Marble series

Emperador Classic



2400x1200mm

Lustrous

✂ 9 mm Thickness

Total faces - 2

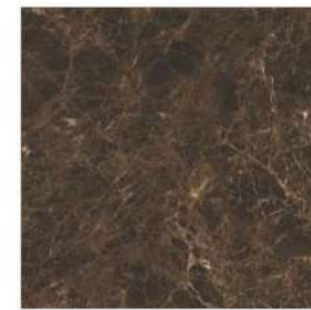

1200x1200mm
Lustrous
9 mm
4 Faces

02.1 Marble series



Marble series

Dyna Classic



2400x1200mm

Lustrous

✂ 9 mm Thickness

Total faces - 4



1200x1200mm
Lustrous
9 mm
4 Faces



Marble series

Grigio Nuvolato



2400x1200mm

Lustrous / Crystalline

✂ 9 mm Thickness

Total faces - 2



1200x1200mm
Lustrous
9 mm
4 Faces

02.1 Marble series



Marble series

Irish Brown



2400x1200mm

Lustrous

✂ 9 mm Thickness

Total faces - 2



Marble series

Silver River



2400x1200mm

Lustrous

✂ 9 mm Thickness

Total faces - 3





Marble series

Serpegiente Italy



2400x1200mm

Lustrous

✂ 9 mm Thickness

Total faces - 3

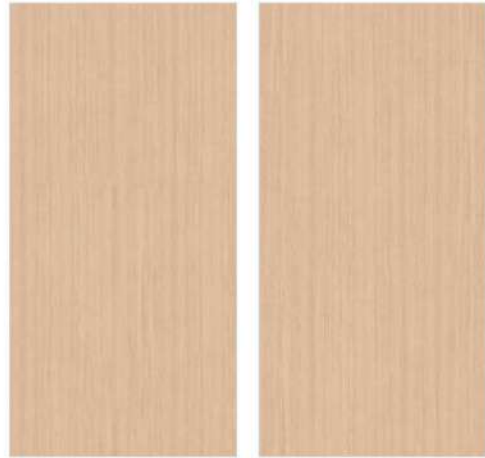

Marble series

Travertine Beige



2400x1200mm

Lustrous / Mute

✂ 6 mm Thickness

✂ 9 mm Thickness

Total faces - 2



1200x1200mm
Lustrous / Satin
9 mm
4 Faces

02.1 Marble series

Hotel Reception

Our large format slabs are an ideal solution to enhance the beauty and grandeur of every hotel reception with our intriguing designs and patterns.

Wall - 1

Celio

3200x1600mm
Crystalline

✂ 9 mm Thickness

Wall - 2

Etnico

3200x1600mm
Crystalline

✂ 9 mm Thickness

Floor

Etnico

3200x1600mm
Crystalline

✂ 9 mm Thickness

Table

Etnico

3200x1600mm
Crystalline

✂ 9 mm Thickness



Wall - 1

Celio

3200x1600mm
Crystalline

✂ 9 mm Thickness

Floor

Etnico

3200x1600mm
Crystalline

✂ 9 mm Thickness





Marble series

Etnico



3200x1600mm

Crystalline

✂ 9 mm Thickness

Total faces - 3



Marble series

Grey William



2400x1200mm

Lustrous

✂ 9 mm Thickness

Total faces - 2



1200x1200mm
Lustrous / Satin
9 mm
4 Faces

02.1 Marble series



Marble series

Pulpis Grey

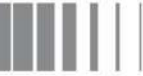

3200x1600mm

Crystalline

✂ 9 mm Thickness

Total faces - 3

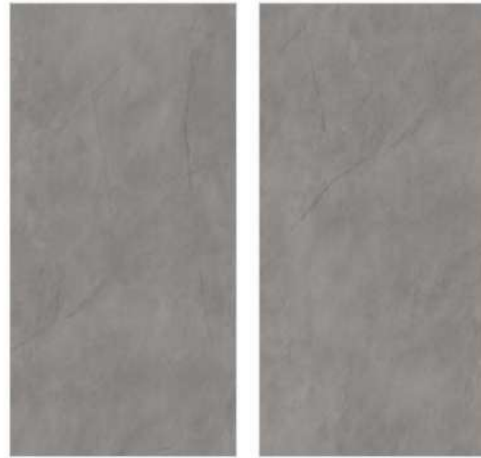

1600x1600mm
Crystalline
9 mm
4 Faces

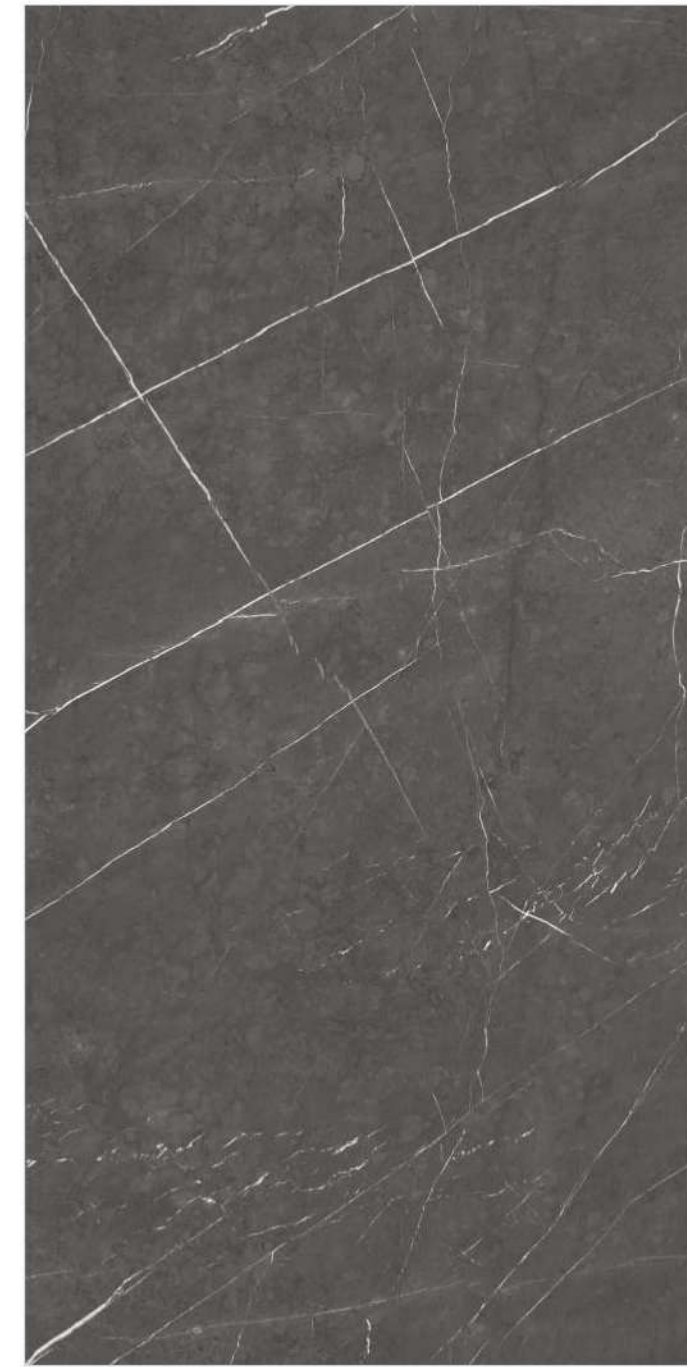

Marble series

Pietra Grey



3200x1600mm

Crystalline / Satin

✂ 6 mm Thickness

✂ 9 mm Thickness

✂ 12 mm Thickness

Total faces - 3

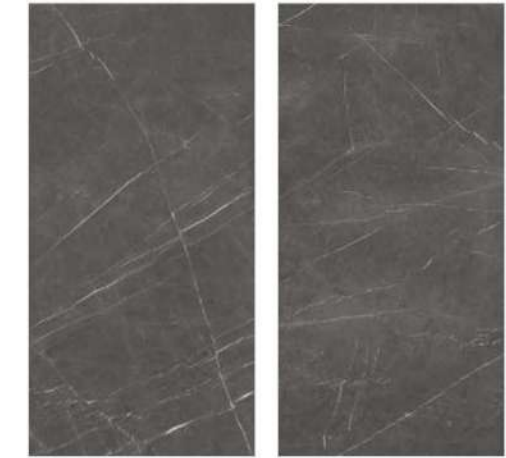

2400x1200mm
Lustrous / Crystalline /
Satin
9 mm
3 Faces

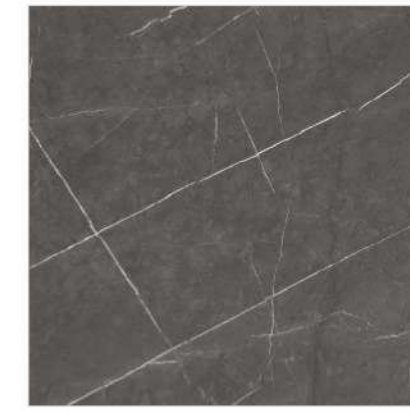

1600x1600mm
Crystalline
9 mm
5 Faces

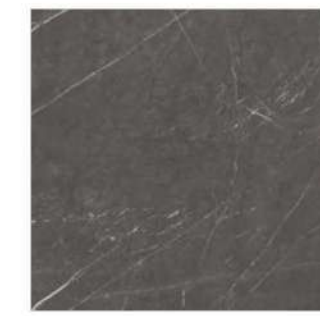

1200x1200mm
Lustrous
9 mm
5 Faces

02.1 Marble series

Luxury Store

Style never takes a day off. Lightning striking on our grey tile. Combining our marble and stone is our glamour's product take on a perfect 'Show Stopper'



Floor

**Astoria
Grey**

2400x1200mm
Lustrous

✂ 9 mm Thickness



Marble series

Astonia Grey



3200x1600mm

Crystalline / Mute

- ✕ 6 mm Thickness
- ✕ 9 mm Thickness
- ✕ 12 mm Thickness

Total faces - 3



2400x1200mm
Lustrous / Crystalline
9 mm
3 Faces

1600x1600mm
Crystalline
9 mm
6 Faces



Marble series

Nordic Grey



2400x1200mm

Lustrous

- ✕ 9 mm Thickness

Total faces - 2



1200x1200mm
Lustrous
9 mm
6 Faces

O2.1 Marble series



Marble series

Nero Marquina

3200x1600mm

Crystalline / Satin

- ✕ 6 mm Thickness
- ✕ 9 mm Thickness
- ✕ 12 mm Thickness

Total faces - 3

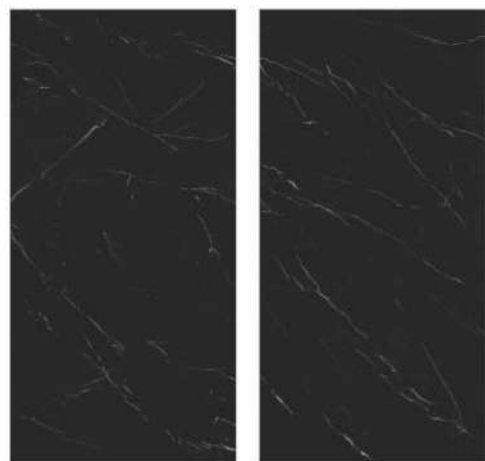

1600x1600mm
Crystalline
9 mm
6 Faces

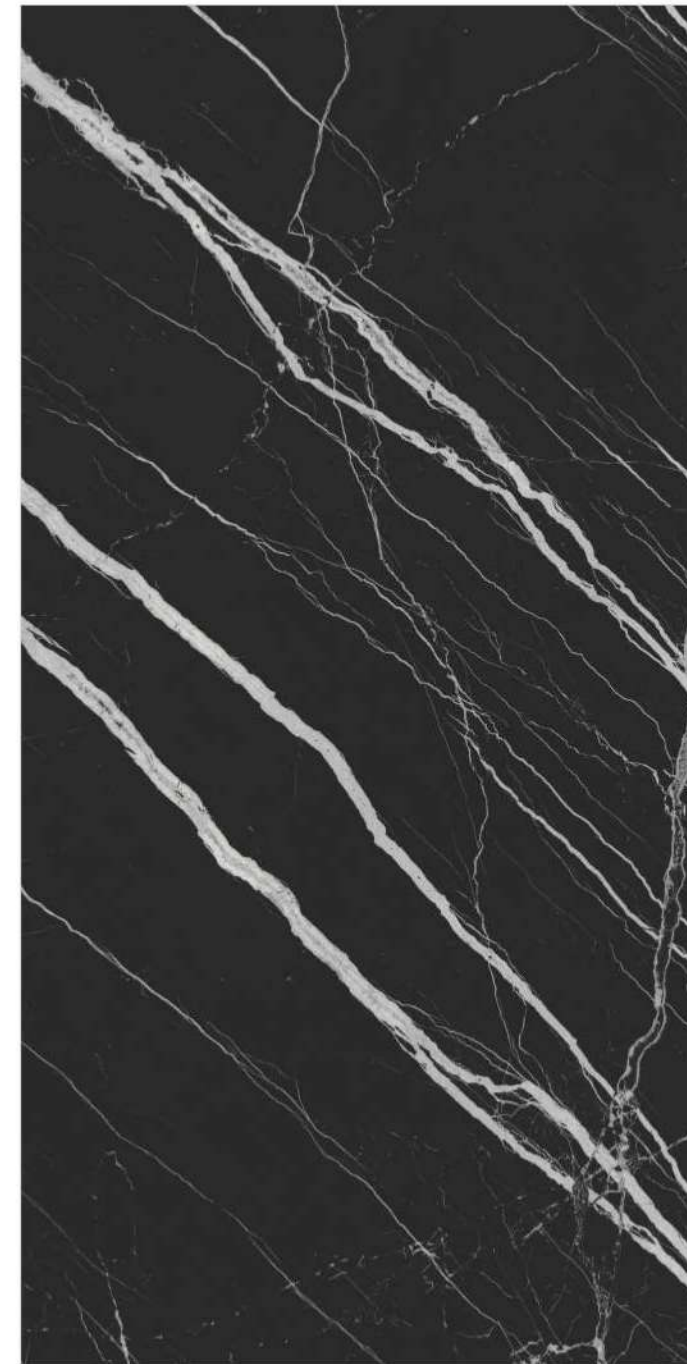

Marble series

Marquina Venatino

2400x1200mm

Lustrous / Crystalline

- ✕ 9 mm Thickness

Total faces - 3

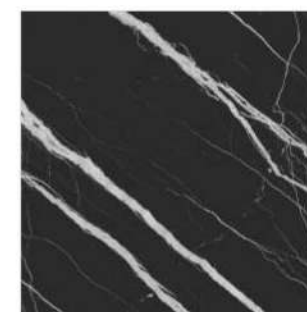
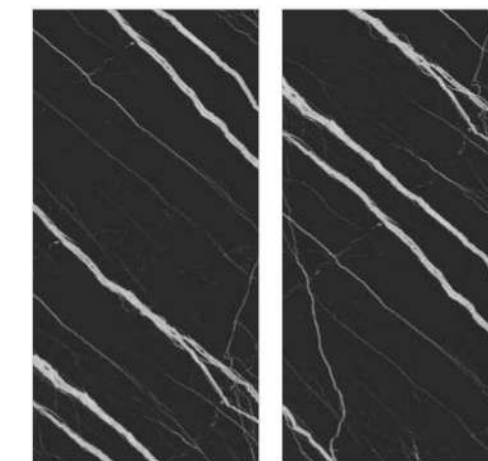

1200x1200mm
Lustrous
9 mm
4 Faces

02.1 Marble series



Marble series

Black Flash



3200x1600mm

Crystalline

✂ 9 mm Thickness

✂ 12 mm Thickness

Total faces - 2



Marble series

Black Fusion



3200x1600mm

Crystalline

✂ 9 mm Thickness

Total faces - 3

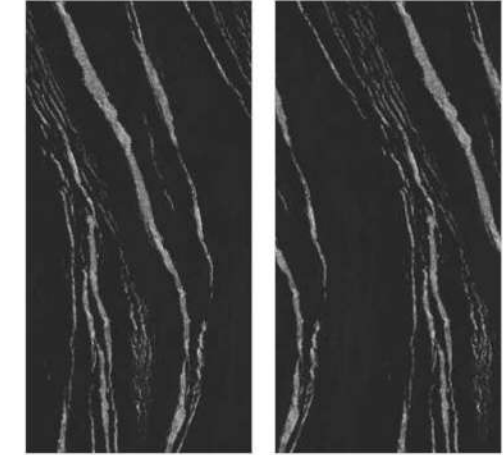



Marble series

White Santorini



3200x1600mm

Crystalline

✂ 9 mm Thickness

Total faces - 3

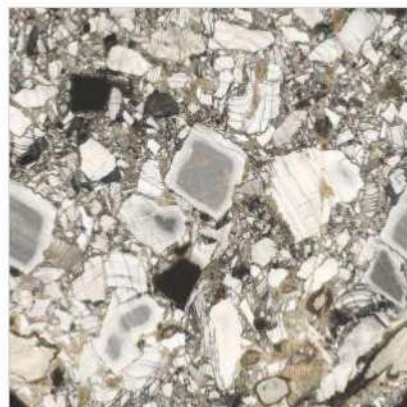
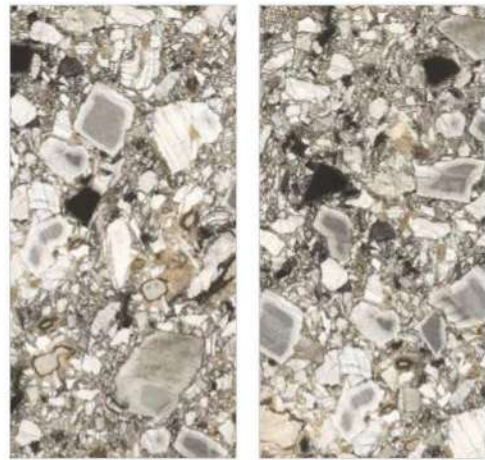

1600x1600mm
Crystalline
9 mm
6 Faces



Marble series

Crema Atlantico



1200x1200mm

Lustrous

✂ 9 mm Thickness

Total faces - 6



Explore the unexplored



02.2 Terrazzo Series

Terrazzo is the latest interior trend and is here to stay. The terrazzo series creates a nostalgic mosaic patterns and is available in Beige and Grey shade options.



Terrazzo series

Cemento Flakes

3200x1600mm



Terrazzo series

Tuscan Chips

2400x1200mm

Sauna Spa

A space that inspires tranquillity and largeness required for the sauna and spa can be crafted from the soothing colour range we offer for the wide tiles.

Wall - 1

Cemento Flakes

1200x1200mm
Mute

✂ 9 mm Thickness

Wall - 2

Cemento Flakes

1200x1200mm
Mute

✂ 9 mm Thickness

Wall - 3

Tuscan Chips

2400x1200mm
Mute

✂ 9 mm Thickness

Floor

Tuscan Chips

2400x1200mm
Mute

✂ 9 mm Thickness





Wall - 1

**Cemento
Flakes**

1200x1200mm
Mute

✂ 9 mm Thickness

Wall - 2

**Cemento
Flakes**

1200x1200mm
Mute

✂ 9 mm Thickness

Wall - 3

**Tuscan
Chips**

2400x1200mm
Mute

✂ 9 mm Thickness

Floor

**Tuscan
Chips**

2400x1200mm
Mute

✂ 9 mm Thickness



Terrazzo series

Tuscan Chips

2400x1200mm

Mute

✂ 9 mm Thickness

Total faces - 2



1200x1200mm
Mute
9 mm
4 Faces

02.2 Terrazzo series



Terrazzo series

Cemento Flakes



3200x1600mm

Mute

✂ 9 mm Thickness

✂ 12 mm Thickness

Total faces - 2



1200x1200mm
Mute
9 mm, 12 mm
4 Faces



Terrazzo series

Beton Flakes Grey



3200x1600mm

Mute

✂ 9 mm Thickness

✂ 12 mm Thickness

Total faces - 2



1200x1200mm
Mute
9 mm
4 Faces

O2.2 Terrazzo series

Explore the unexplored

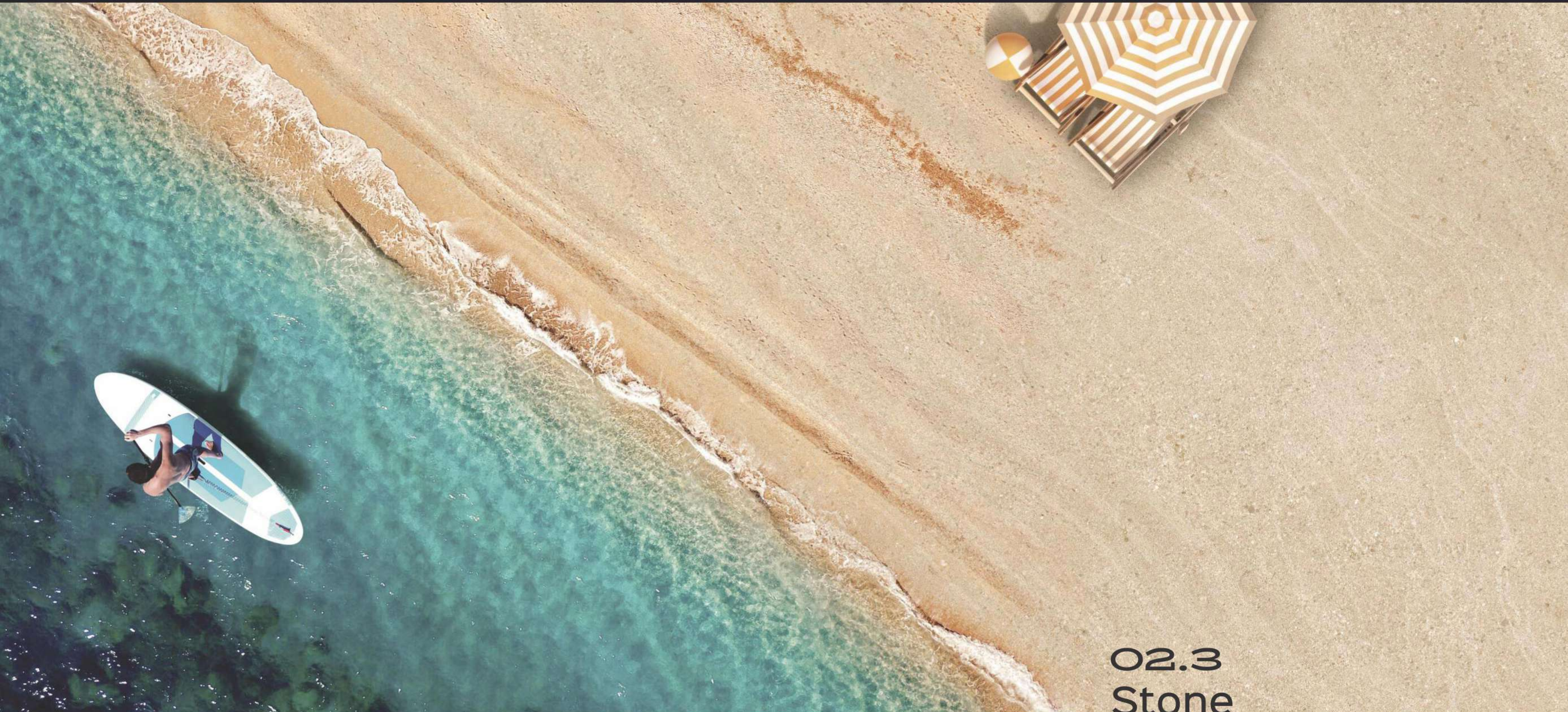

02.3 Stone Series

Scout into our stone series as it extracts the essence of nature with tiles as wide as the sky, you will be lost into the beauty of this journey.



Stone series

Ignazio



2400x1200mm

Lustrous / Mute

✂ 9 mm Thickness

Total faces - 3



Stone series

Mountain Latte



3200x1600mm

Mute

✂ 6 mm Thickness

✂ 9 mm Thickness

✂ 12 mm Thickness

Total faces - 3



2400x1200mm
Mute
6 mm, 9 mm
3 Faces

Color Options

Mountain Coin

Mountain Tortora

Mountain Antracite



3200x1600mm
2400x1200mm
Mute
6 mm, 9 mm 12 mm
3 Faces

3200x1600mm
2400x1200mm
Mute
6 mm, 9 mm 12 mm
3 Faces

3600x1600mm
2400x1200mm
Mute
6 mm, 9 mm 12 mm
3 Faces

Cafeteria

Coffee evokes a good mood, so unwind and 'ESPRESSO YOURSELF'

A time to take a break and enjoy warm ambience with the grandeur and colors splashed with our stone series adding cordial grunge to our industrial trendy interiors.

Wall

Nero Marquina

3200x1600mm
Crystalline

✂ 6 mm Thickness

✂ 9 mm Thickness

Floor

Ardesia Grigio

2400x1200mm
Mute

✂ 9 mm Thickness

Bar Table / Platform

Statuario

3200x1600mm
Crystalline

✂ 6 mm Thickness



Stone series

Ardesia Brown



2400x1200mm

Mute

✕ 6 mm Thickness

✕ 9 mm Thickness

Total faces - 4

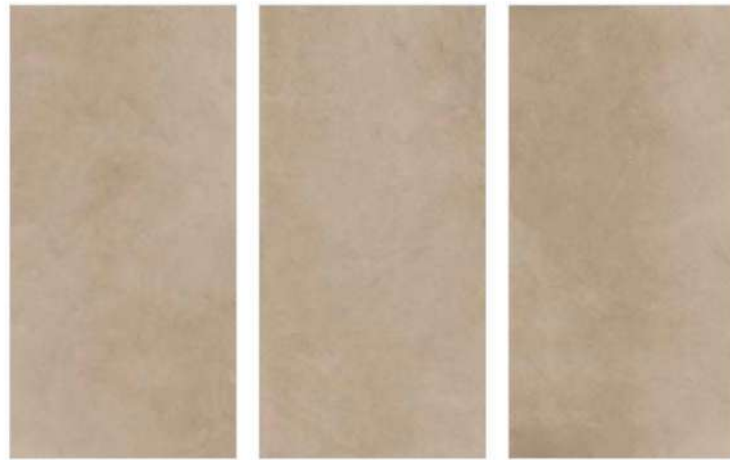

Color Options

Ardesia Silver

Ardesia Grigio

Ardesia Antracite



2400x1200mm
Mute
6 mm, 9 mm
4 Faces

2400x1200mm
Mute
6 mm, 9 mm
4 Faces

2400x1200mm
Mute
6 mm, 9 mm
4 Faces



Stone series

Arenisca Crema



2400x1200mm

Mute

✕ 9 mm Thickness

Total faces - 3



Color Options

Arenisca Night



1200x1200mm
Mute
9 mm
6 Faces

2400x1200mm
1200x1200mm
Mute
9 mm
3 Faces



Stone series

Pias Pearl

2400x1200mm

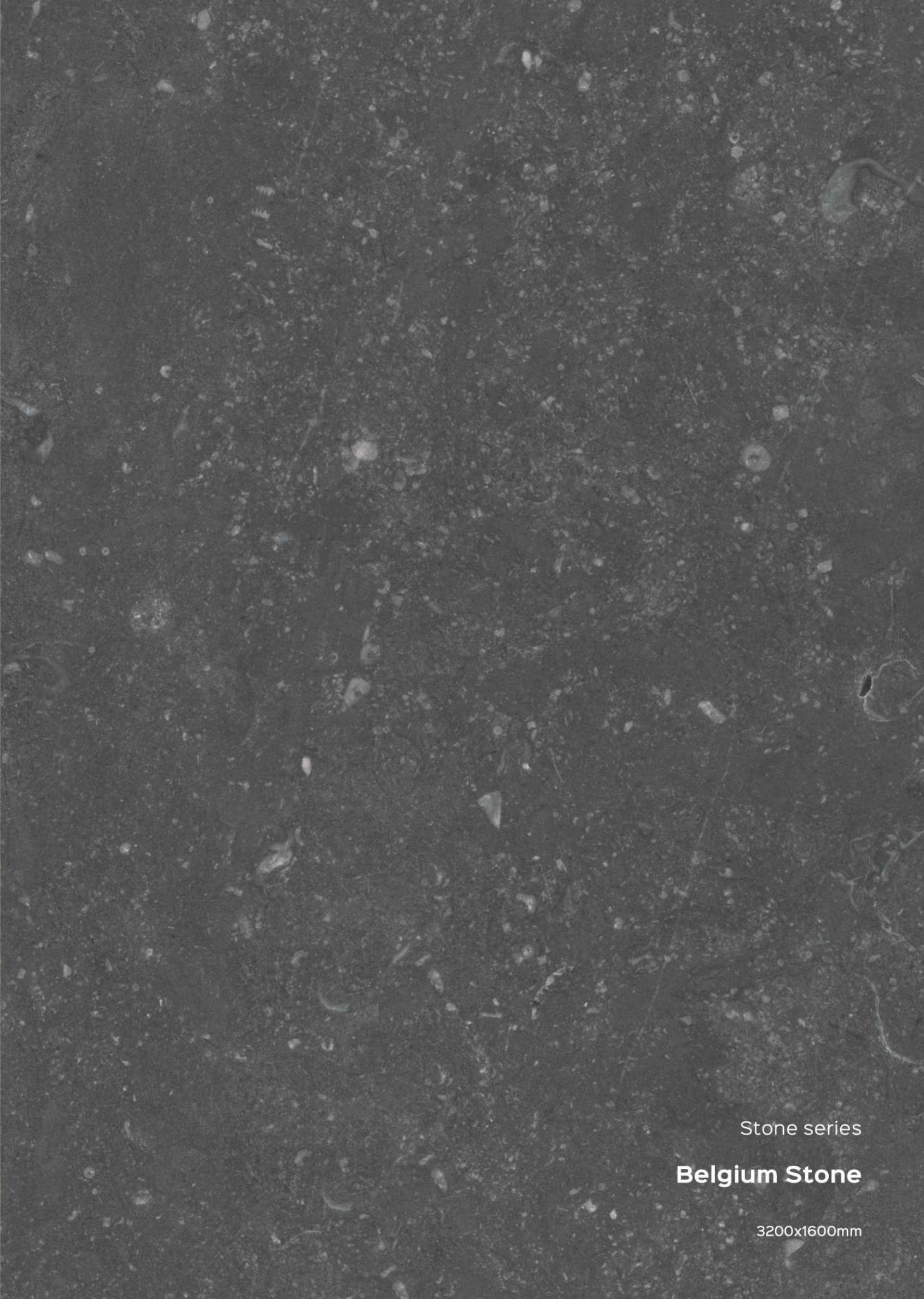

Stone series

Belgium Stone

3200x1600mm



Stone series

Pias Pearl

2400x1200mm

Mute

✂ 9 mm Thickness

Total faces - 3



Color Options

Pias Bronze

Pias Silver



2400x1200mm
Mute
9 mm
3 Faces

2400x1200mm
Mute
9 mm
3 Faces

Stone series

Belgium Stone

3200x1600mm

Orgatech

✂ 6 mm Thickness

✂ 9 mm Thickness

✂ 12 mm Thickness

Total faces - 2



1600x1600mm
Orgatech
6 mm, 9 mm, 12 mm
4 Faces

Island Kitchen

A free flow space in your island kitchen interiors can be covered with our unmatched shades and design from our selective tile range which offers expanse and simplicity.

Floor

**Seiser
Slate**

2400x1200mm
Mute

✂ 9 mm Thickness

Kitchen Platform

**Lithic
Nero**

2400x1200mm
Mute

✂ 6 mm Thickness

Drawer

**Timber
Bruno**

2400x1200mm
Mute

✂ 6 mm Thickness

Dining Table

**Timber
Bruno**

2400x1200mm
Mute

✂ 6 mm Thickness





Floor

**Seiser
Slate**

2400x1200mm
Mute

✂ 9 mm Thickness

Kitchen Platform

**Lithic
Nero**

2400x1200mm
Mute

✂ 6 mm Thickness

Drawer

**Timber
Bruno**

2400x1200mm
Mute

✂ 6 mm Thickness

Stone series

Seiser Coco

2400x1200mm

Mute

✂ 9 mm Thickness

Total faces - 2



Color Options

Seiser Slate



1200x1200mm
Mute
9 mm
4 Faces

02.3 Stone series

2400x1200mm
1200x1200mm
Mute
9 mm
2 Faces



Stone series

Castello Latte



1200x1200mm

Mute

✂ 9 mm Thickness

Total faces - 4



Color Options

Castello Coin



1200x1200mm
Mute
9 mm
4 Faces

Castello Grigio



1200x1200mm
Mute
9 mm
4 Faces

Castello Antracite



1200x1200mm
Mute
9 mm
4 Faces



Stone series

Avola Desert



1200x1200mm

Mute

✂ 9 mm Thickness

Total faces - 4



Color Options

Avola Mocha



1200x1200mm
Mute
9 mm
4 Faces

02.3 Stone series

Explore the unexplored



02.4 Concrete Series

The strong and vivacious the Concrete series will be
delight to explore as you must expect the
unexpected.



Concrete series

Lithic Latte

2400x1200mm

Concrete series

Lithic Nero

2400x1200mm

Facade

A facade of a building is often the most important aspect from a design standpoint. With our latest technology and physical properties. Our products can be used on exterior facade and due to light weight helps in easy product installation.

Wall - Light Tiles

**Lithic
Latte**

2400x1200mm
Mute

✂ 6 mm Thickness

Wall - Dark Tiles

**Lithic
Nero**

2400x1200mm
Mute

✂ 6 mm Thickness

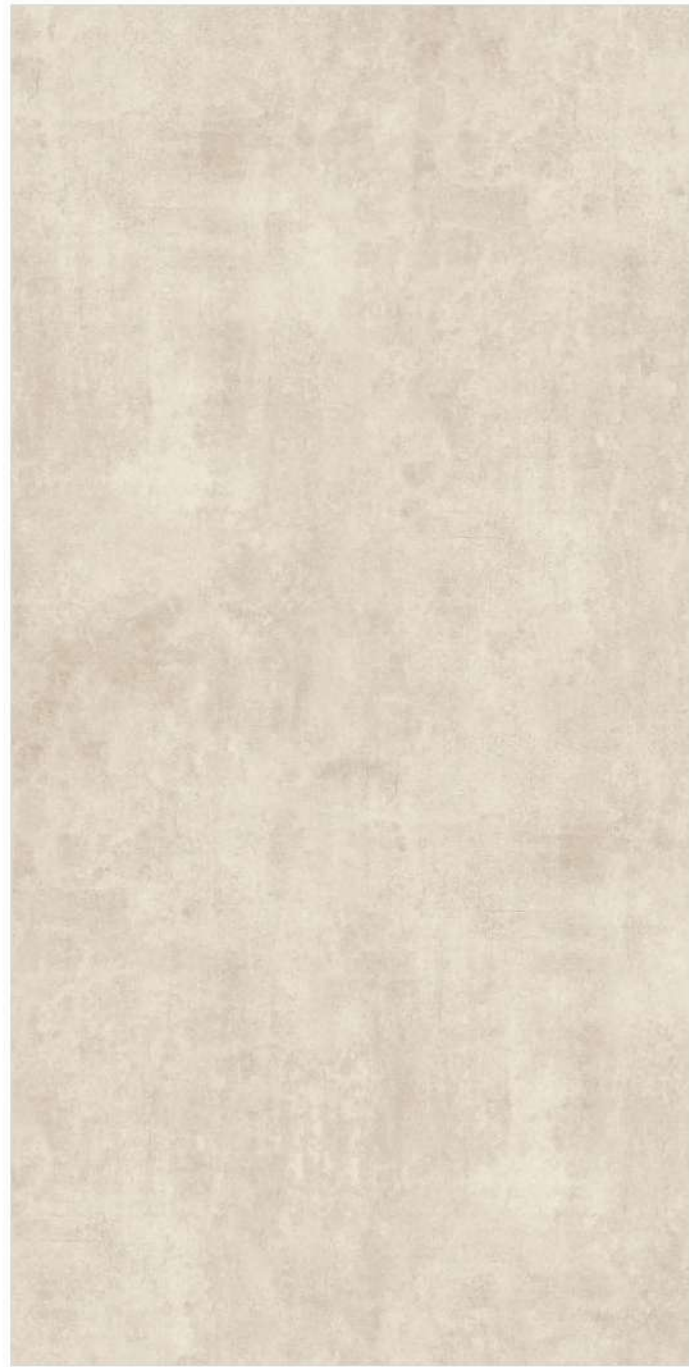

Concrete series

Lithic Latte

2400x1200mm

Mute

✕ 6 mm Thickness

✕ 9 mm Thickness

Total faces - 3

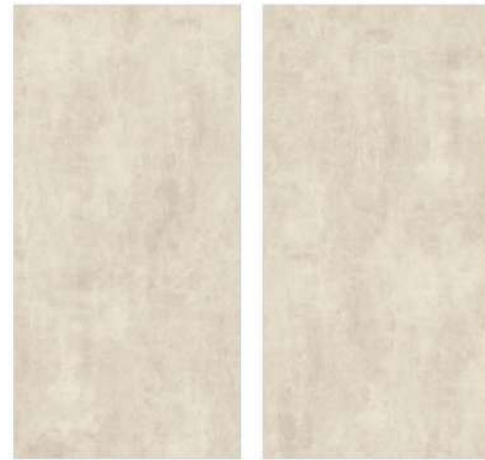

Color Options



1200x1200mm
Mute
9 mm
4 Faces

2400x1200mm
1200x1200mm
Mute
6 mm, 9 mm
3 Faces

2400x1200mm
1200x1200mm
Mute
6 mm, 9 mm
3 Faces

2400x1200mm
1200x1200mm
Mute
6 mm, 9 mm
3 Faces

2400x1200mm
1200x1200mm
Mute
6 mm, 9 mm
3 Faces



Concrete series

**Exposed Cemento
Fabrico Latte**

3200x1600mm

Mute

✕ 9 mm Thickness

✕ 12 mm Thickness

Total faces - 2



Color Options

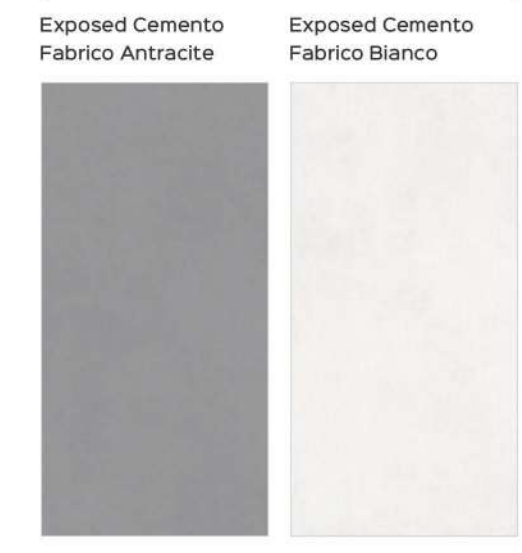

1600x1600mm
Mute
9 mm
4 Faces

3200x1600mm
1600x1600mm
Mute
9 mm, 12 mm
2 Faces

3200x1600mm
1600x1600mm
Mute
9 mm, 12 mm
2 Faces

Relaxation Room

A serene and blissful enclosure, the relaxation room will be a cake walk, once you choose the subtle tile forms out of our eye-pleasing tile collection.

Wall - 1

Black Flash

3200x1600mm
Crystalline

✂ 9 mm Thickness

Wall - 2

Black Fusion

3200x1600mm
Crystalline

✂ 9 mm Thickness

Floor

Cemento Antracite

1600x1600mm
Mute

✂ 9 mm Thickness

Fire Area

Cemento Tortora

1600x1600mm
Mute

✂ 9 mm Thickness





Wall - 2

Black Fusion

3200x1600mm
Crystalline

✂ 9 mm Thickness

Floor

Cemento Antracite

1600x1600mm
Mute

✂ 9 mm Thickness

Concrete series

Cemento Beige



1600x1600mm

Mute

✂ 9 mm Thickness



Total faces - 4

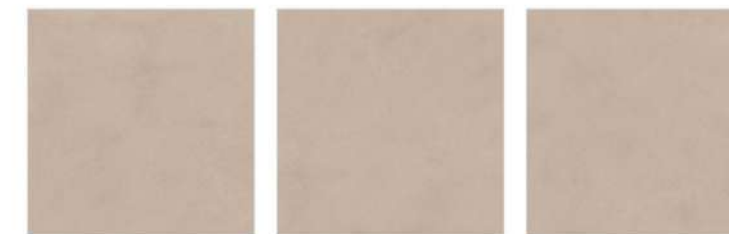

Color Options

Cemento Bianco



1600x1600mm
Mute
9 mm
4 Faces

Cemento Antracite

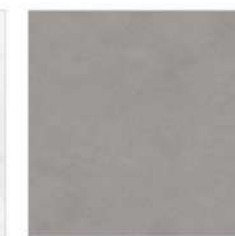

1600x1600mm
Mute
9 mm
4 Faces

Cemento Tortora

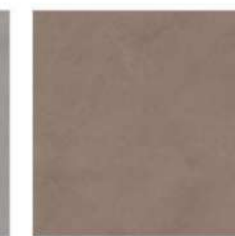

1600x1600mm
Mute
9 mm
4 Faces

02.4 Concrete series

138 - 139

Explore the unexplored

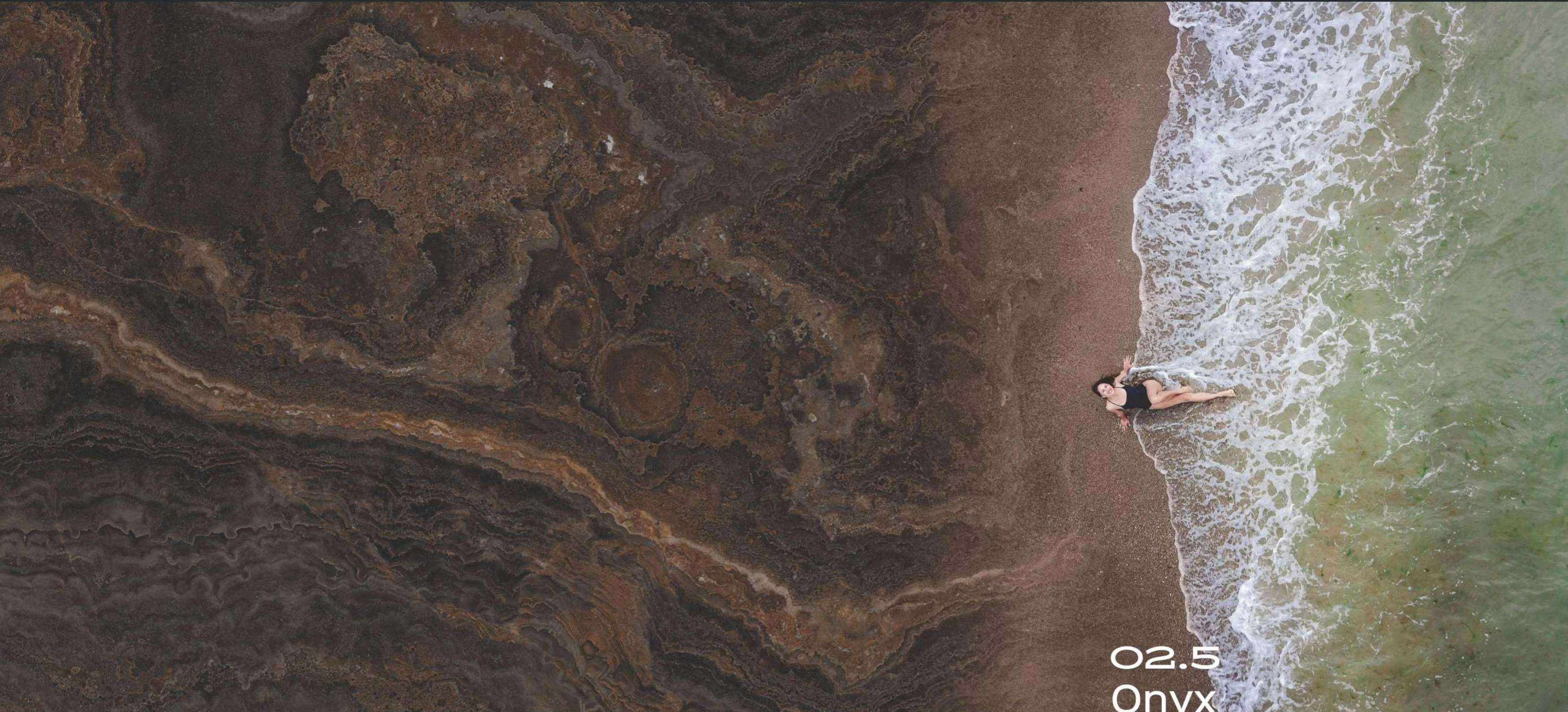

02.5 Onyx Series

Soft and delicate colour effect combined with spectacular opulence of the tile size comprises our exquisite range of onyx series.



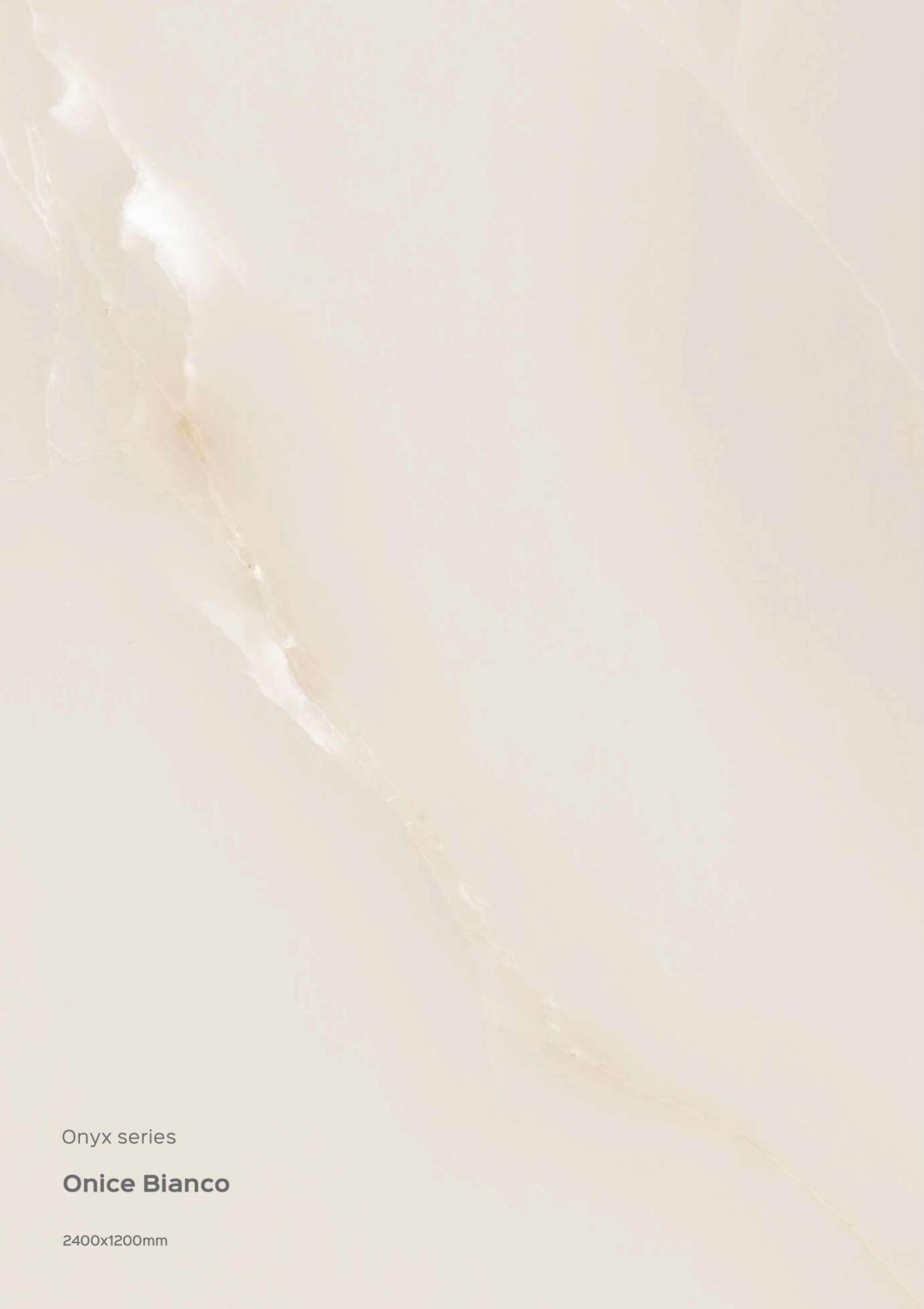

Onyx series

Onice Bianco

2400x1200mm

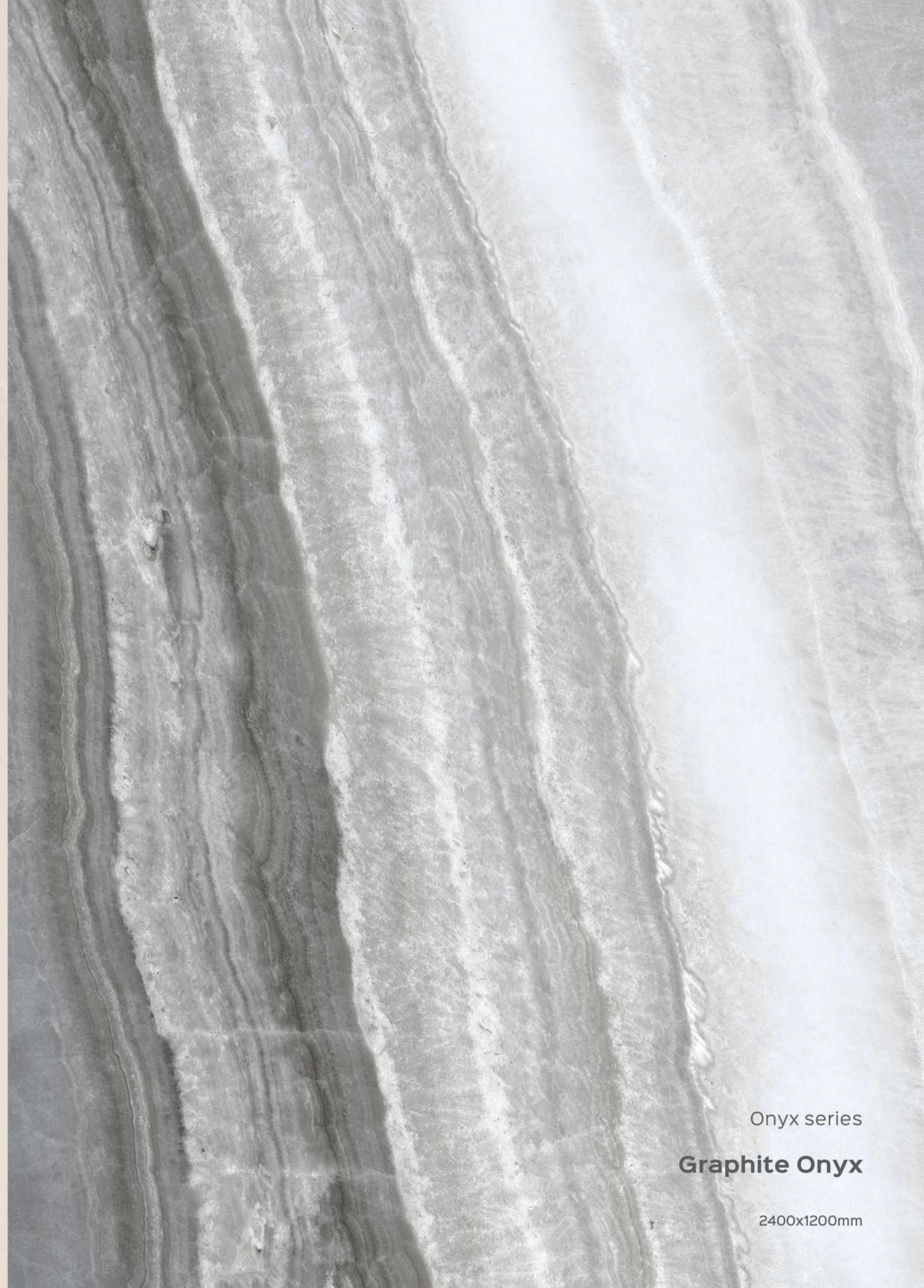

Onyx series

Graphite Onyx

2400x1200mm

Commercial

Business & Waiting Area

The mangamous spread of your business and waiting area can be designed with the handpicked tiles from our fine range.



Wall - 1

**Onice
Bianco**

2400x1200mm
Lustrous

✂ 9 mm Thickness

Wall - 2

**Seiser
Coco**

2400x1200mm
Mute

✂ 9 mm Thickness

Floor

**Seiser
Coco**

2400x1200mm
Mute

✂ 9 mm Thickness



Onyx series

Onice Bianco



2400x1200mm

Lustrous

✂ 9 mm Thickness

Total faces - 3



Color Options

Onice Rosado



2400x1200mm
Lustrous
9 mm
3 Faces



Onyx series

Graphite Onyx



2400x1200mm

Lustrous / Crystalline

✂ 9 mm Thickness

Total faces - 3

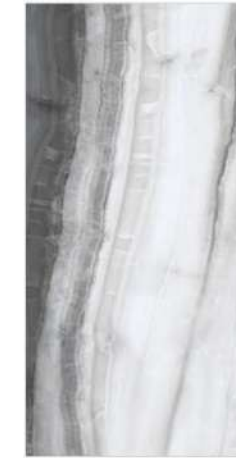



Onyx series

Fantasy Onyx



3200x1600mm

Crystalline

✂ 9 mm Thickness

✂ 12 mm Thickness

Total faces - 3



1600x1600mm
Crystalline
9 mm
5 Faces



Onyx series

Honey Onyx



3200x1600mm

Crystalline

✂ 9 mm Thickness

✂ 12 mm Thickness

Total faces - 2



2400x1200mm
Crystalline
9 mm, 12 mm
2 Faces



1600x1600mm
Crystalline
9 mm, 12 mm
4 Faces

O2.5 Onyx series

Explore the unexplored



02.6 Orgatech Series

The slick and sophisticated. orgatech series is a treat for the eyes, slaying with its enlarged angles.





Orgatech series

Twine Gris

2400x1200mm



Orgatech series

Keronix Smoke

2400x1200mm

Bar

The residential facade will stand strong with its length, take your pick from the luminous and arty style range of tiles to add beauty.

Wall

**Twine
Noir**

2400x1200mm
Orgatech

✂ 6 mm Thickness

Floor

**Twine
Noir**

2400x1200mm
Orgatech

✂ 6 mm Thickness

Top Counter

**Cava
Antracite**

3200x1600mm
Orgatech

✂ 6 mm Thickness



Orgatech series

Twine Gris



2400x1200mm

Orgatech / Satin

✂ 6 mm Thickness

Total faces - 3

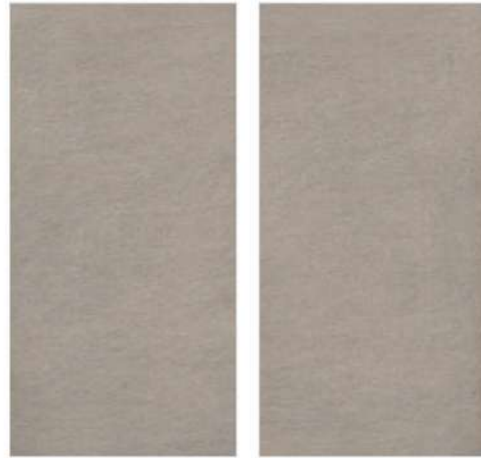

Color Options

Twine Noir



2400x1200mm
Orgatech / Satin
6 mm
3 Faces



Orgatech series

Foster Crema



2400x1200mm

Orgatech

✂ 9 mm Thickness



Orgatech series

Grunge Copper



3200x1600mm

Orgatech

- ✕ 6 mm Thickness
- ✕ 9 mm Thickness
- ✕ 12 mm Thickness

Total faces - 2



2400x1200mm
Orgatech
9 mm
2 Faces



Orgatech series

Rust Cotto



3200x1600mm

Orgatech

- ✕ 6 mm Thickness
- ✕ 12 mm Thickness

Total faces - 2



2400x1200mm
Orgatech
6 mm, 9 mm, 12 mm
2 Faces

O2.6 Orgatech series

Bar

From refreshment space to party conversations has endless memories. The vintage look in tile that overjoyed everyone's mood.

Wall

**Keronix
Smoke**

2400x1200mm
Orgatech

✂ 9 mm Thickness

Floor

**Keronix
Smoke**

2400x1200mm
Orgatech

✂ 9 mm Thickness

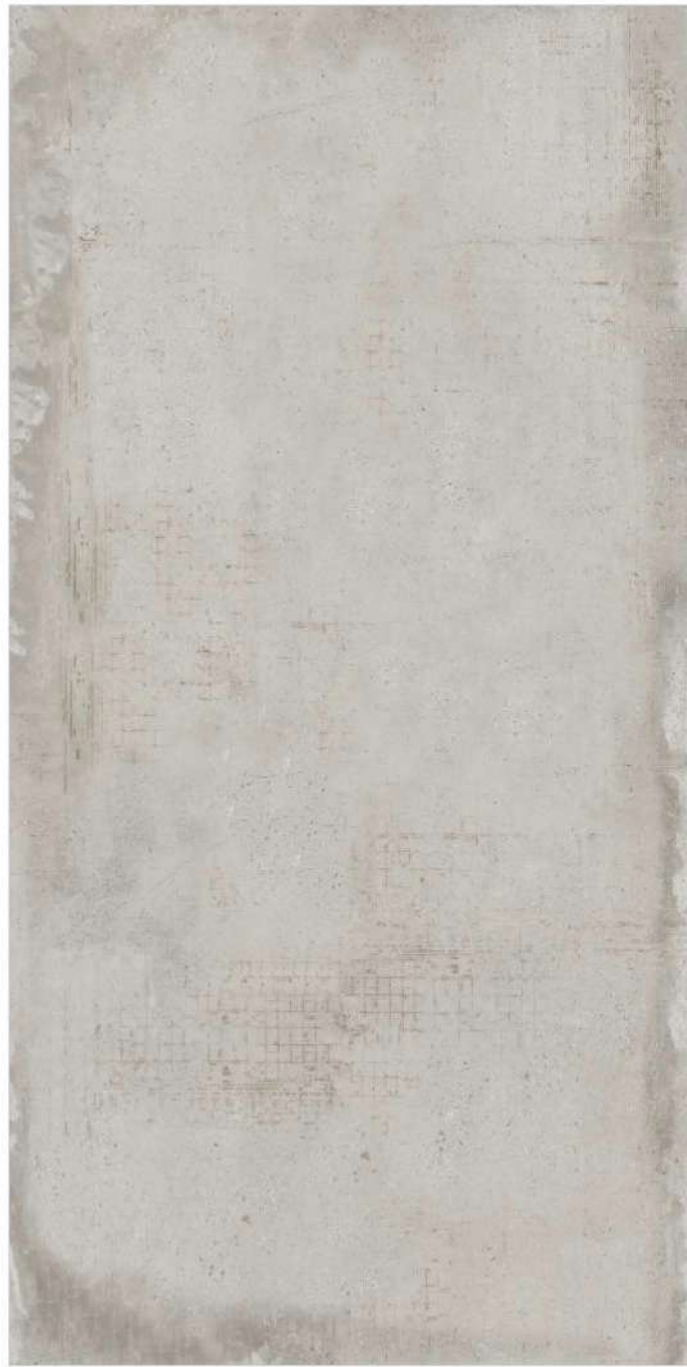

Orgatech series

Keronix Smoke



2400x1200mm

Orgatech

✂ 9 mm Thickness

Total faces - 2



Color Options

Keronix Sand



2400x1200mm
Orgatech
9 mm
2 Faces



Orgatech series

Iron Moss



3200x1600mm

Orgatech

✂ 6 mm Thickness

✂ 9 mm Thickness

✂ 12 mm Thickness

Total faces - 2



Color Options

Iron Corten

Iron Grey



3200x1600mm
Orgatech
6 mm, 9 mm, 12 mm
2 Faces

3200x1600mm
Orgatech
6 mm, 9 mm, 12 mm
2 Faces



Orgatech series

Meta Moss

3200x1600mm

Orgatech

- ✕ 6 mm Thickness
- ✕ 9 mm Thickness
- ✕ 12 mm Thickness



Color Options

Meta Nero



3200x1600mm
2400x1200mm
Orgatech
6 mm, 9 mm, 12 mm

2400x1200mm
Orgatech
6 mm, 9 mm



Orgatech series

Ossido Ash

3200x1600mm

Orgatech

- ✕ 6 mm Thickness
- ✕ 9 mm Thickness
- ✕ 12 mm Thickness

Total faces - 2



Color Options

Ossido Blue



3200x1600mm
Orgatech
6 mm, 9 mm, 12 mm
2 Faces



Orgatech series

Black Bamboo



2400x1200mm

Orgatech / Satin

✂ 9 mm Thickness

✂ 12 mm Thickness

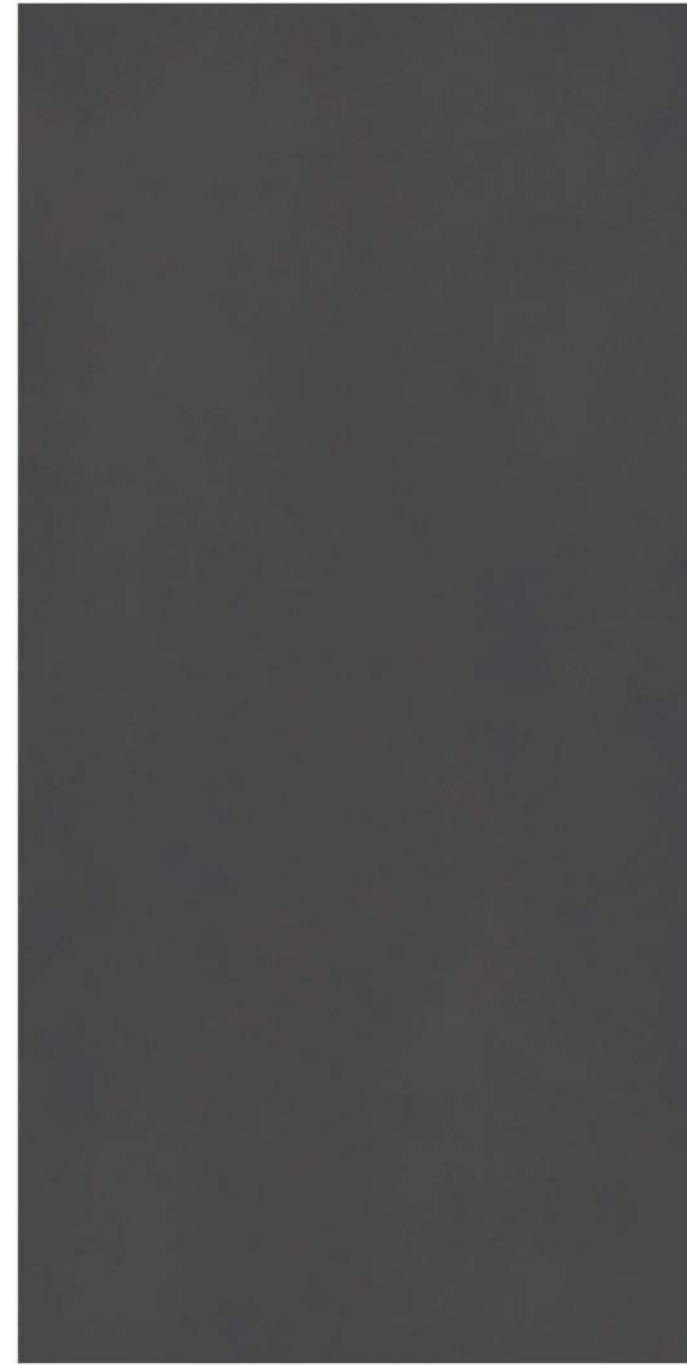

Orgatech series

Cava Antracite



3200x1600mm

Orgatech

✂ 6 mm Thickness

✂ 9 mm Thickness

✂ 12 mm Thickness

Total faces - 2



Explore the unexplored

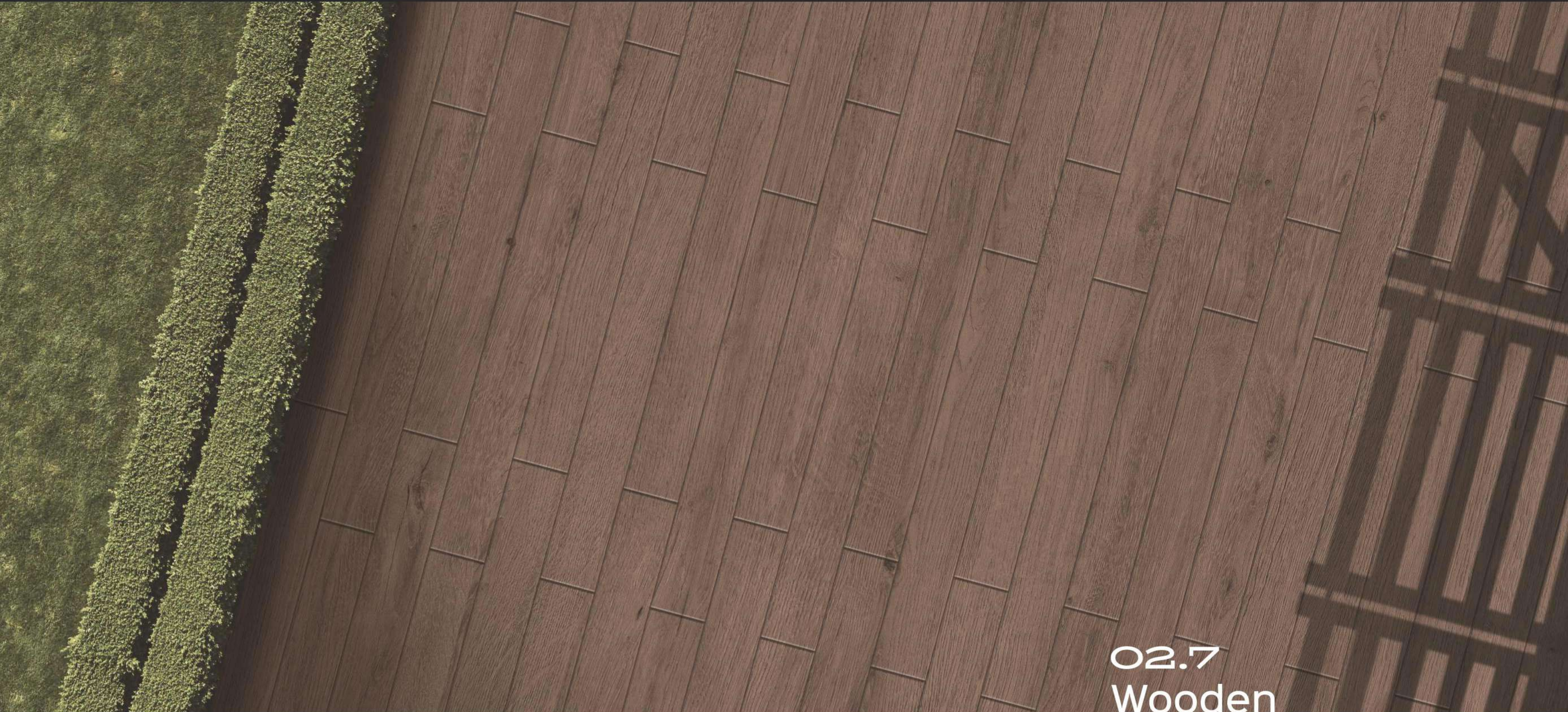

02.7 Wooden Series

Astonishingly mesmerising collection for the wilderness lovers.



A close-up photograph of a light-colored wood grain, showing vertical lines and subtle variations in tone. The texture is smooth and natural.

Wooden series

Timber Bianco

2400x1200mm

A close-up photograph of a dark brown wood grain, showing vertical lines and prominent knots. The texture is rich and detailed.

Wooden series

Timber Bruno

2400x1200mm

Commercial

Florist Shop

The dreamy yet natural texture of our tile range will flawlessly blend into the colourful flower placements at the florist shop.

Wall

Timber Bianco

2400x1200mm
Mute

✂ 6 mm Thickness

Floor

Timber Bianco

2400x1200mm
Mute

✂ 6 mm Thickness

Counter Table

Cava Antracite

3200x1600mm
Orgatech

✂ 6 mm Thickness



Wall
Timber Bianco
 2400x1200mm
Mute
 ✕ 6 mm Thickness

Floor
Timber Bianco
 2400x1200mm
Mute
 ✕ 6 mm Thickness

Counter Table
Cava Antracite
 3200x1600mm
Orgatech
 ✕ 6 mm Thickness



Wooden series

Timber Bianco

2400x1200mm

Mute

✕ 6 mm Thickness

Total faces - 3



Color Options

Timber Silver

Timber Bruno



2400x1200mm
 Mute
 6 mm
 3 Faces

2400x1200mm
 Mute
 6 mm
 3 Faces

Explore the unexplored

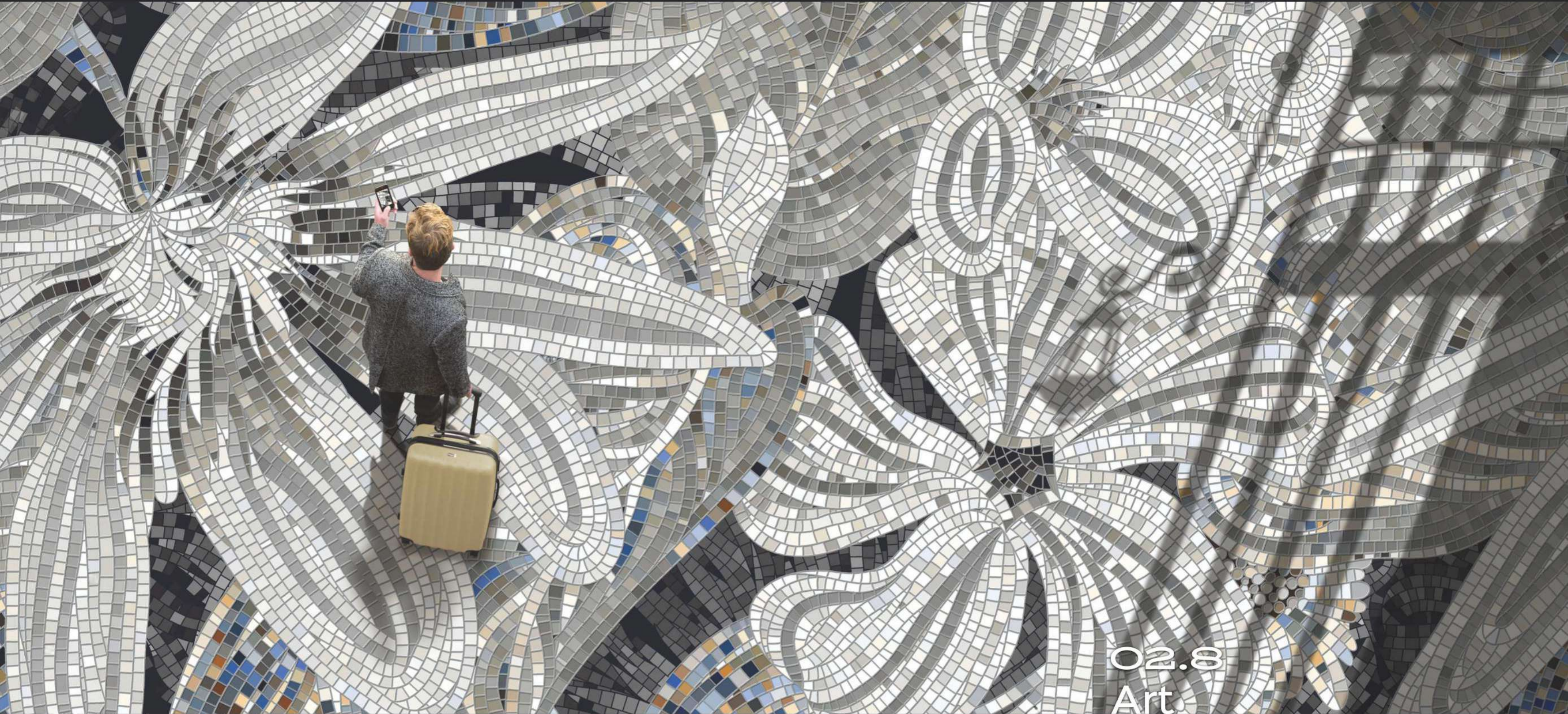

02.8 Art. Series

Channelize the inner artist in you with our bold yet intricate art series, experience a world, never seen before.

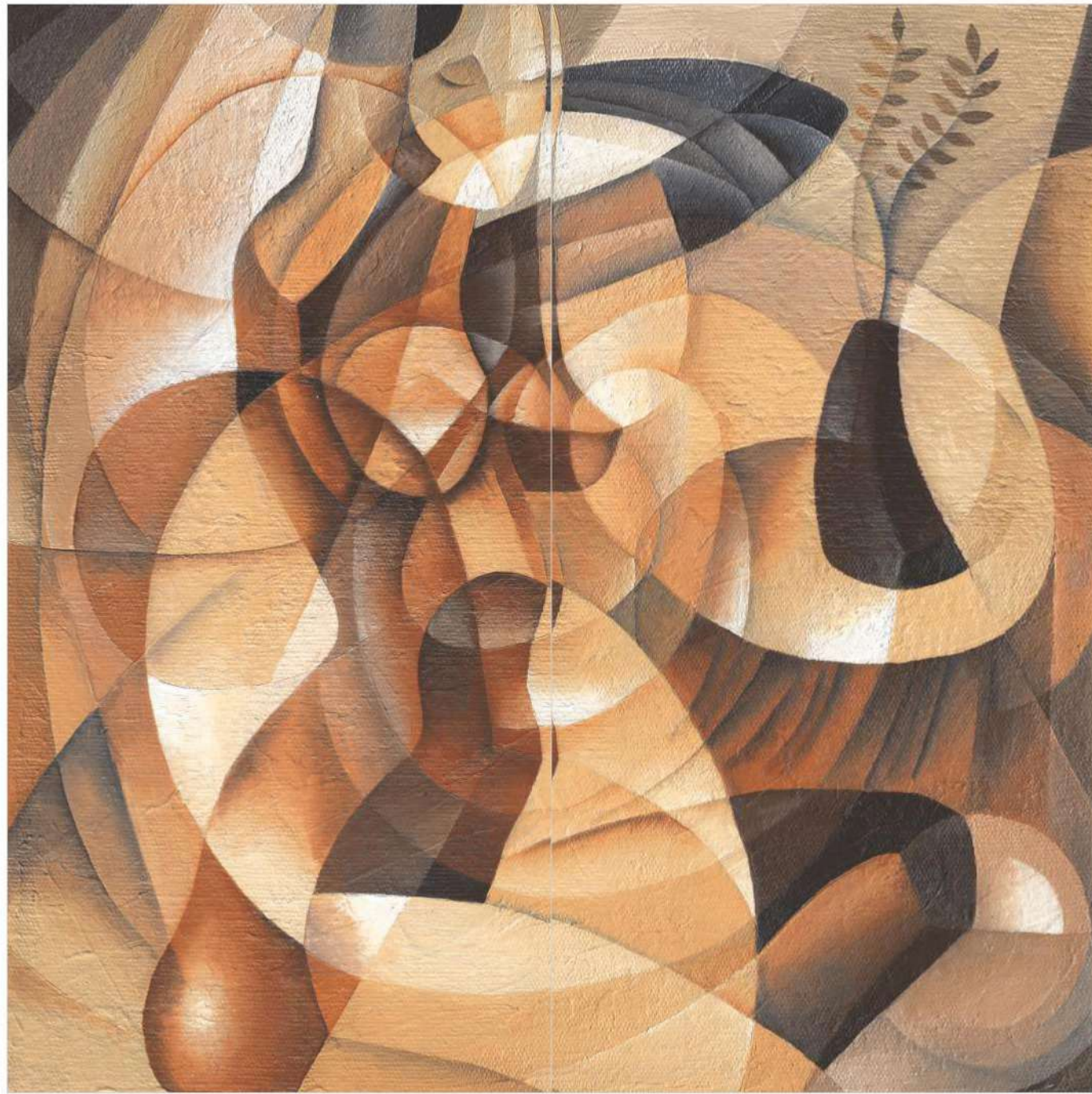

Total faces - 2

Art series

Abstrato Moda



2400x1200mm

Crystalline

✂ 9 mm Thickness



Art series

Flora Mosaic



2400x1200mm

Lustrous

✂ 9 mm Thickness

Explore the unexplored



02.9 Bookmatch

The impeccably-clever designs available in our bookmatch will manifest a splendidly stunning interior decor style for your space.





Bookmatch

Calacutta Borghini

3200x1600mm

Kitchen

A classy and premium tile collection for the residential kitchen make your dreams come true, incorporating the functionality criteria as well.

Wall - Bookmatch

**Calacutta
Borghini**

3200x1600mm
Crystalline

✂ 6 mm Thickness

Wall

**Calacutta
Borghini**

1600x1600mm
Crystalline

✂ 9 mm Thickness

Floor

**Calacutta
Borghini**

1600x1600mm
Crystalline

✂ 9 mm Thickness

Kitchen Platform

Carrara

2400x1200mm
Lustrous

✂ 6 mm Thickness



Wall
Calacutta Borghini

1600x1600mm
Crystalline

✂ 9 mm Thickness

Floor
Calacutta Borghini

1600x1600mm
Crystalline

✂ 9 mm Thickness

Kitchen Platform
Carrara

2400x1200mm
Lustrous

✂ 6 mm Thickness



Bookmatch

Calacutta Borghini

3200x1600mm

Crystalline / Satin

✂ 6 mm Thickness

✂ 9 mm Thickness

✂ 12 mm Thickness

Bookmatch



Layout A

Bookmatch



Layout B



Bookmatch

Apuane Statuario



3200x1600mm

Crystalline / Satin

✂ 6 mm Thickness

✂ 9 mm Thickness

✂ 12 mm Thickness

Bookmatch

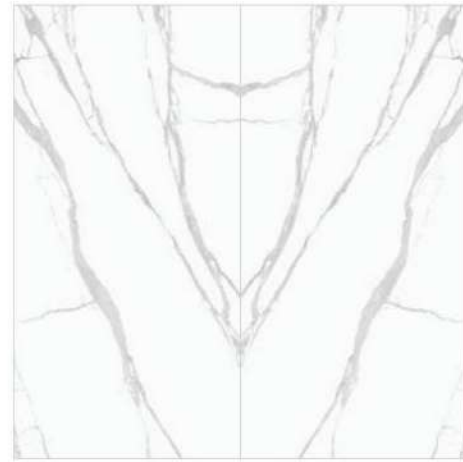

Layout A

Bookmatch

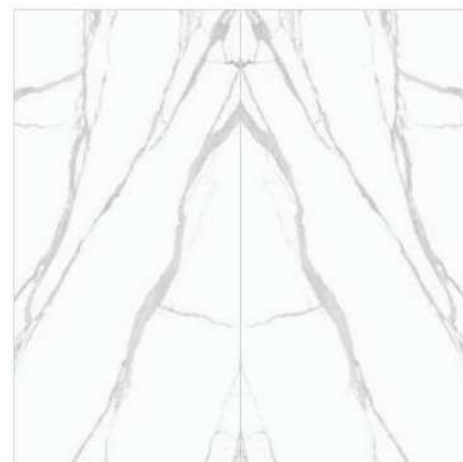

Layout B



2400x1200mm
Lustrous / Crystalline /
Satin
6 mm, 9 mm
Bookmatch
Lustrous /
Satin



Bookmatch

Statuario Venetian



2400x1200mm

Lustrous / Crystalline / Satin

✂ 6 mm Thickness

✂ 9 mm Thickness

Bookmatch

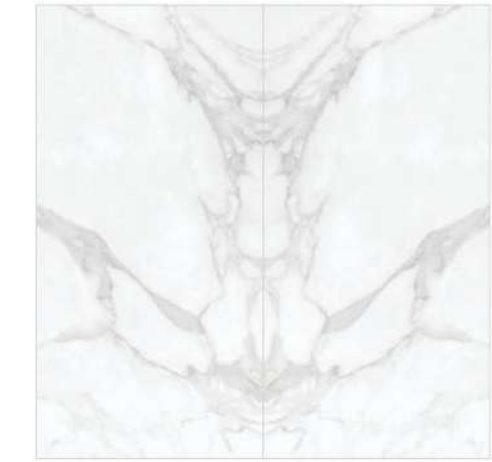

Layout A

Bookmatch

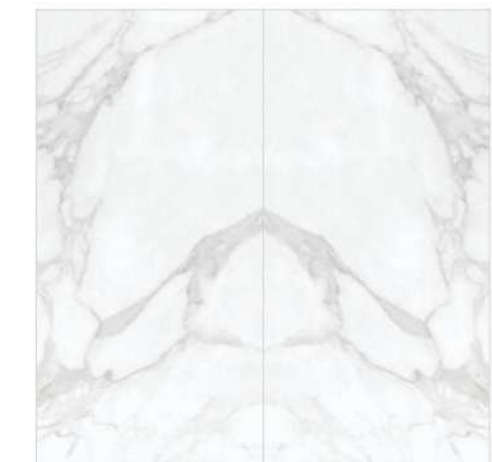

Layout B



Bookmatch

Statuario Venato



3200x1600mm

Crystalline / Satin

- ✂ 6 mm Thickness
- ✂ 9 mm Thickness
- ✂ 12 mm Thickness

Bookmatch

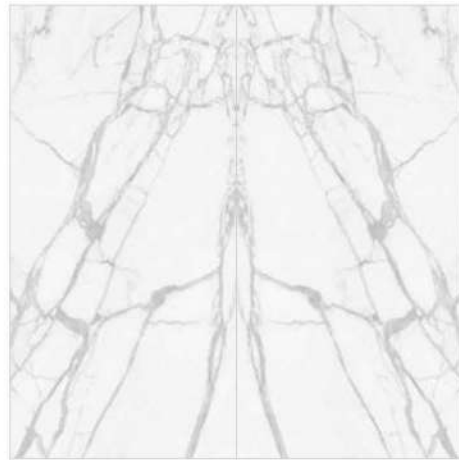

Layout A

Bookmatch

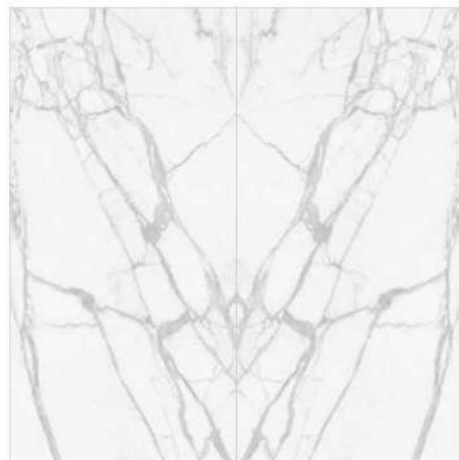

Layout B



Bookmatch

Statuario Platina



3200x1600mm

Crystalline / Satin

- ✂ 6 mm Thickness
- ✂ 9 mm Thickness
- ✂ 12 mm Thickness

Bookmatch



Layout A

Bookmatch



Layout B



2400x1200mm
Lustrous / Crystalline /
Satin
6 mm, 9 mm
Bookmatch

02.9 Bookmatch

Kitchen

Catering to the residential dining hall area, there are many tile design variants which can set new design trends with our contemporary styles.

Wall - Bookmatch

Dolce Grey

2400x1200mm
Lustrous

✂ 9 mm Thickness

Wall - Dark

Pietra Grey

3200x1600mm
Satin

✂ 6 mm Thickness

Kitchen Over Head

Statuario Venetian

2400x1200mm
Satin

✂ 6 mm Thickness

Kitchen Platform Top

Statuario Venetian

2400x1200mm
Satin

✂ 6 mm Thickness

Kitchen Platform Wall

Dolce Grey

2400x1200mm
Lustrous

✂ 9 mm Thickness





Kitchen Platform Wall

Dolce Grey

2400x1200mm
Lustrous

✂ 9 mm Thickness

Floor

Beton Flakes Grey

3200x1600mm
Mute

✂ 9 mm Thickness



Kitchen Island - Dark

Pietra Grey

3200x1600mm
Crystalline

✂ 6 mm Thickness

Kitchen Island - Light

Dolce Grey

2400x1200mm
Lustrous

✂ 6 mm Thickness



Bookmatch

Dolce Grey



2400x1200mm

Lustrous

✂ 9 mm Thickness

Bookmatch



Layout A

Bookmatch



Layout B



Bookmatch

Breccia Blue



2400x1200mm

Lustrous

✂ 9 mm Thickness

Bookmatch



Layout A

Bookmatch



Layout B



Bookmatch

Graphite Onyx



2400x1200mm

Lustrous / Crystalline

✂ 9 mm Thickness

Bookmatch

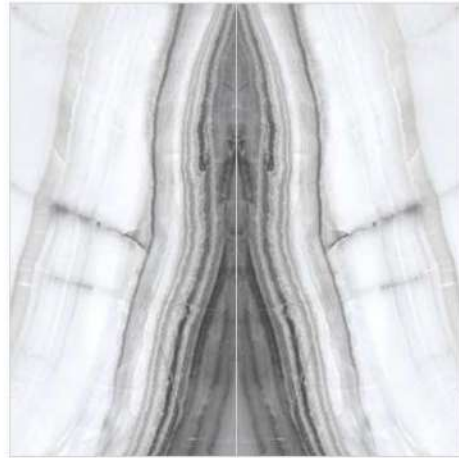

Layout A

Bookmatch

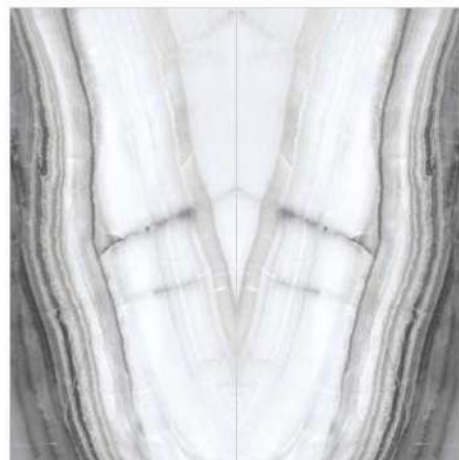

Layout B



Bookmatch

Flora Mosaic



2400x1200mm

Lustrous

✂ 9 mm Thickness

Bookmatch



Layout A

Bookmatch



Layout B

Explore the unexplored



02.10 Meek Series

Flavours that makes you hungry and where master chef shows its creativity. Let the aesthetic essence and hygienic tile quality take a step ahead.



Ideal characteristics for
kitchen countertop

Fullbody

12 mm Thickness

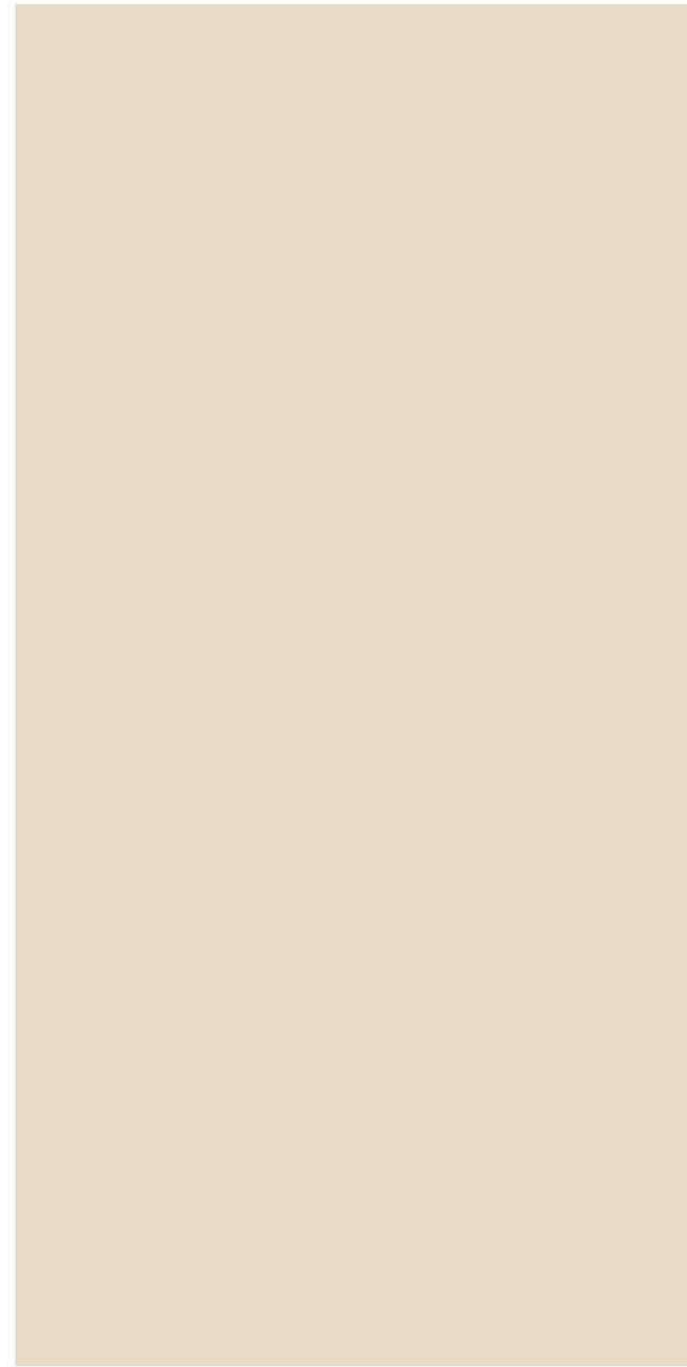
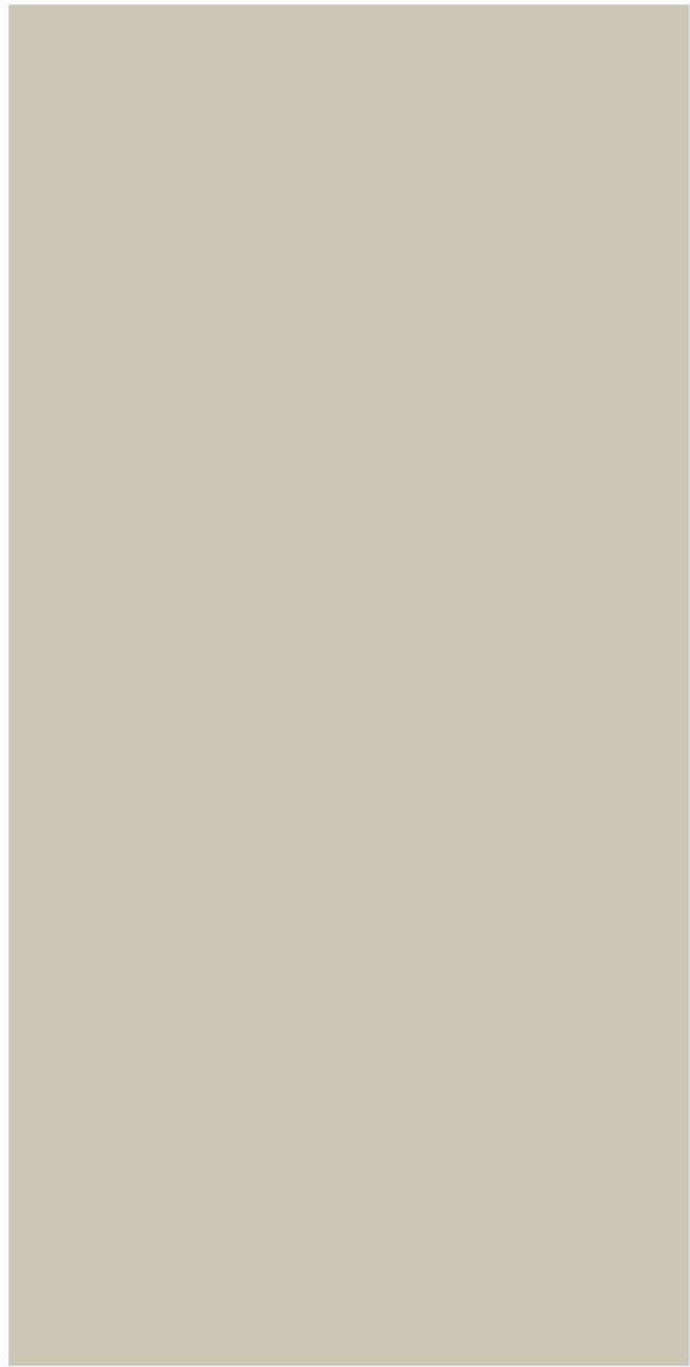

Meek series

Meek Oyster

3200x1600mm

Crystalline / Satin

Fullbody

✂ 12 mm Thickness

Meek series

Meek Mocha

3200x1600mm

Crystalline / Satin

Fullbody

✂ 12 mm Thickness

Meek series

Meek Corn

3200x1600mm

Crystalline / Satin

Fullbody

✂ 12 mm Thickness

Meek series

Meek Barista

3200x1600mm

Crystalline / Satin

Fullbody

✂ 12 mm Thickness

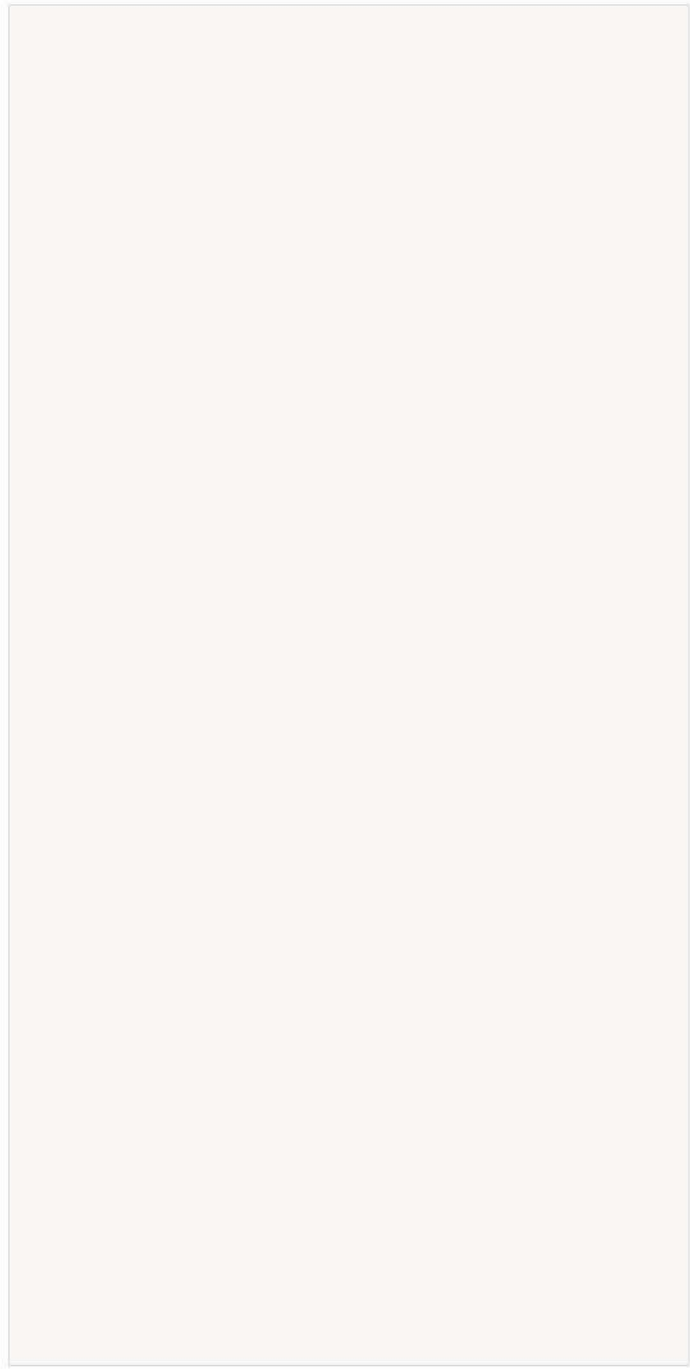

Meek series

Meek Artic 

3200x1600mm

Crystalline / Satin

Fullbody

 12 mm Thickness

Meek series

Meek Smoke 

3200x1600mm

Crystalline / Satin

Fullbody

 12 mm Thickness

Meek series

Meek Ash 

3200x1600mm

Crystalline / Satin

Fullbody

 12 mm Thickness

Meek series

Meek Umber 

3200x1600mm

Crystalline / Satin

Fullbody

 12 mm Thickness

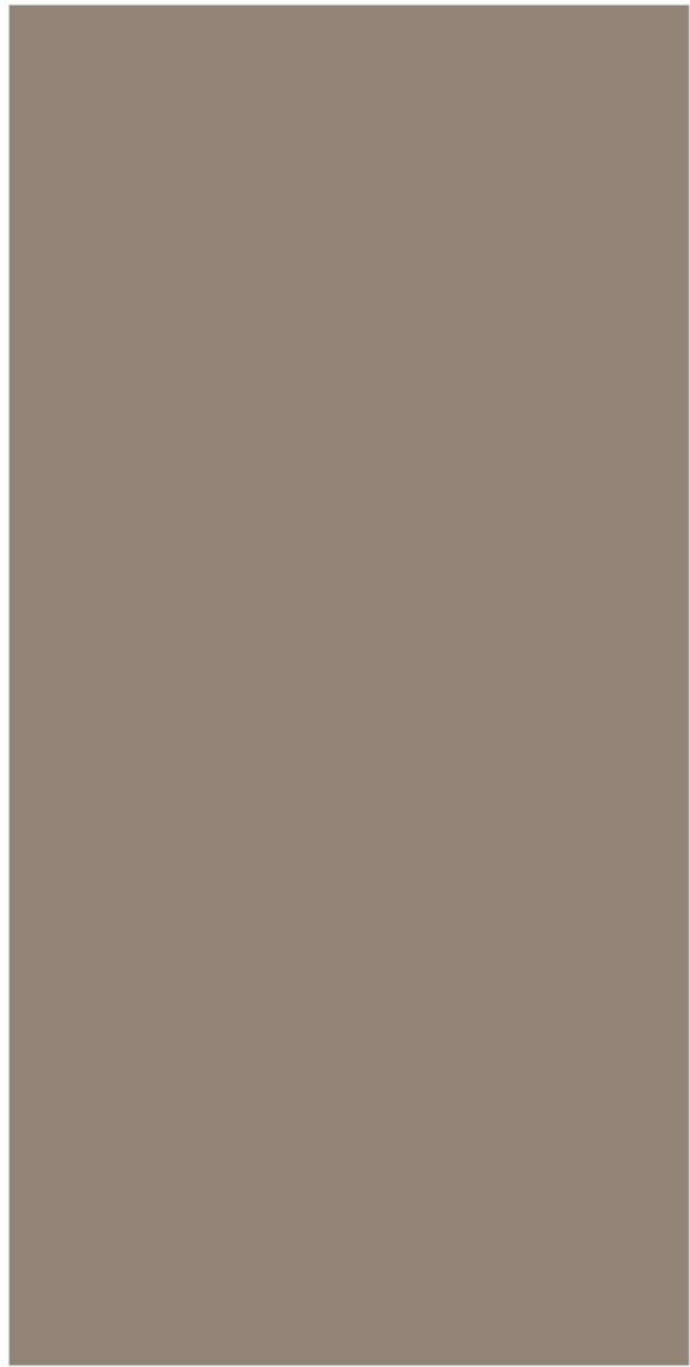

Meek series

Meek Walnut 

3200x1600mm

Crystalline / Satin

Fullbody

 12 mm Thickness

Meek series

Meek Coal 

3200x1600mm

Crystalline / Satin

Fullbody

 12 mm Thickness

03.1 Transportation & Handling

03.1.1 Transporting TechnoSLAB

Following is a common slab storage situation; it highlights problems that can result from improper securing. The cargo transport unit of TechnoSLAB is formed on two "A - shaped" frames, provided by us. (Fig. 1 & 2)

Research into regulatory guidance from other sources did not uncover any recommendations specifically concerning natural stone slabs and road transportation, but the Swedish National Road and Transport Research (VTI) Institute issued recommendations for the transportation of panels more than 15 years ago, which are illustrated in (Fig. 3)

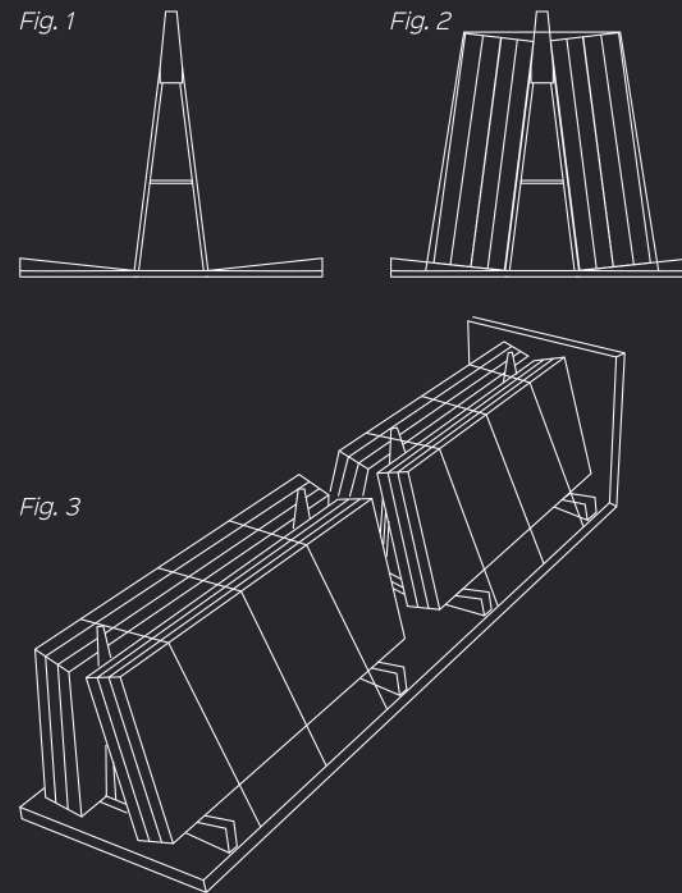

03.1.2 Manually transporting a TechnoSLAB

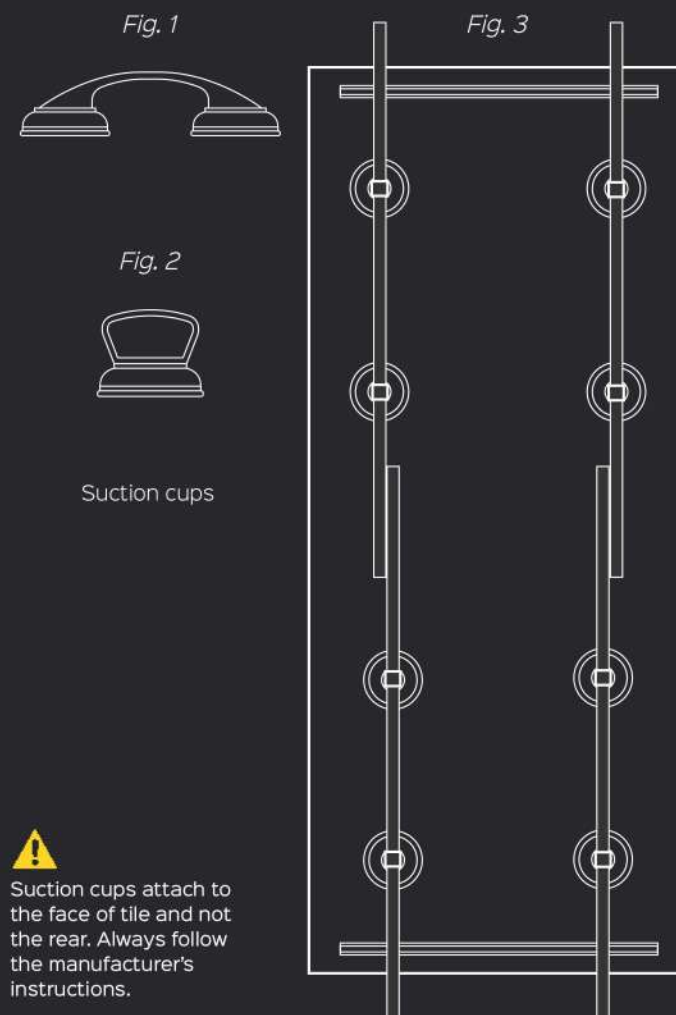

Typical suction cups (Fig. 2) of different kinds are a prime aid, although a couple of workers will be needed to carry the tiles and these may still get deformed.

To allow the extraction of the slabs in a safe and easy way, it is recommended to position the pallets in a suitable area where the lift truck can be moved round all sides of the pallet.

In the case of tiles with a textured surface, soft rubber suction pads (Fig. 1) should be used to ensure a strong grip. Suction pads fixed to a lifting bar will make it easier to handle the products and prevent them from becoming deformed. By using two of these bars, all kind of operations can be performed by just two people.

However, the best solution is to use a rigid lifting frame (Fig. 3) with suction cups that grip the tile on all four sides.

The lifting frame can be designed to adapt to all tile formats, sizes or cut sections, keeping the tiles undamaged and allowing them to be handled by fewer people.

Possible operations

1. To remove the tiles from the box
2. To place them on the work table
3. To carry them anywhere on the work site
4. To spread cement-based adhesive on the underside
5. To help lay them



Suction cups attach to the face of tile and not the rear. Always follow the manufacturer's instructions.

03.1.3 Manually transporting a TechnoSLAB

TechnoSLAB is extremely heavy and may have sharp edges. It is therefore necessary to wear protective gloves at all times. We recommend the use of single or double suction cups which help to ensure the integrity of the tile is maintained and the operators' safety is not compromised. Carefully wipe the surface of the tile to remove any dust or moisture. Position the suction cups on the face of the tile and make sure that they adhere to the surface properly.

For safe handling of large format slabs on-site we highly recommend the use of a specialist tile handling frame with suction cup, such as the TechnoSLAB Easy-Move. For larger formats the full frame with four suction cups is suitable, with smaller formats two double suction cups are sufficient.

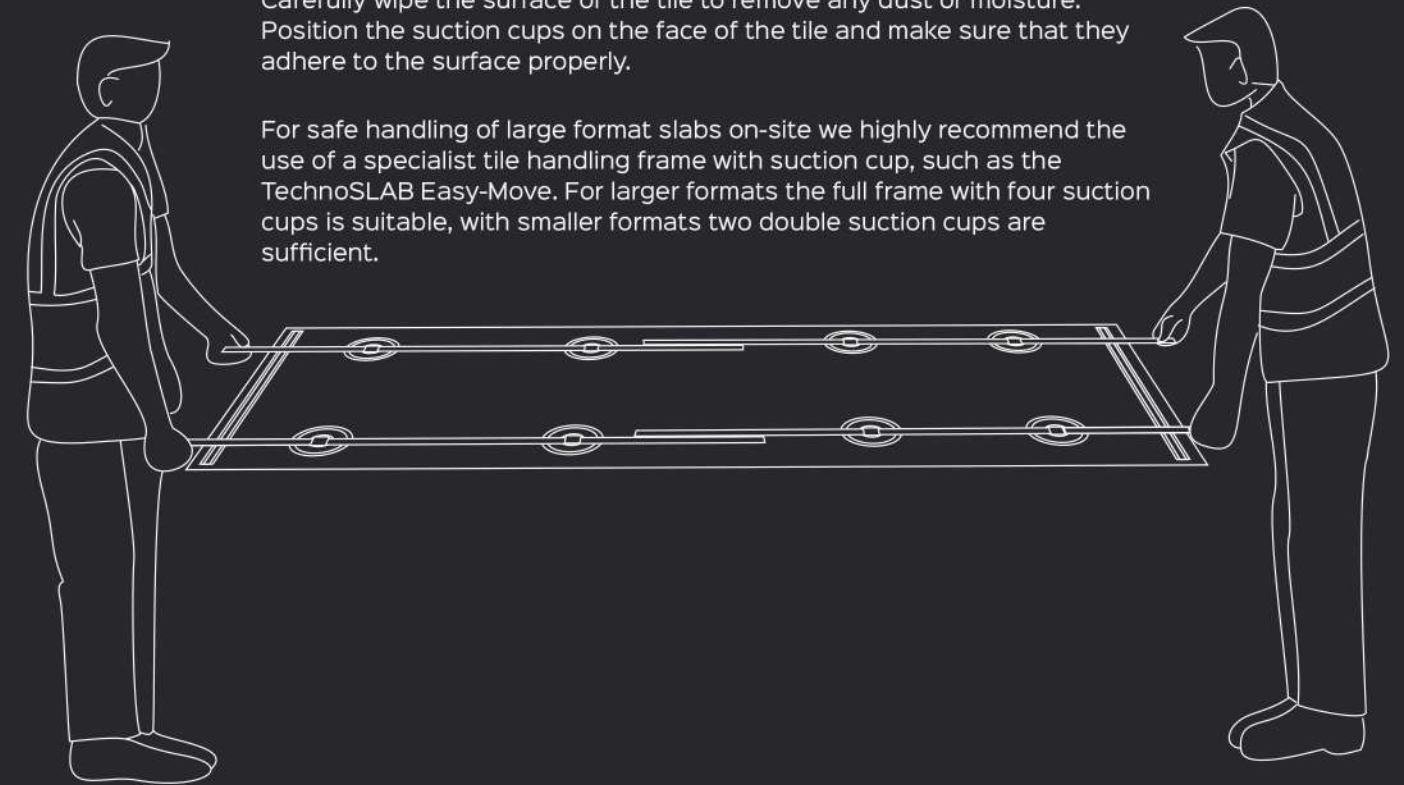

03.2 Storage

Place the slabs length-wise on wooden beams to prevent the slabs from splintering.

4mm & 6mm slabs needs at least three support points, distributed evenly along the back of the slab; a full support is recommended. For example - an unused granite or marble slab with sufficient width. The best way to maintain the integrity of the slabs is to keep them in their original Packaging or use a full support on the back of the TechnoSLAB such as an unused granite or marble slab which is wide enough.

The supports must be able to hold the entire surface of the part during transport. Too small supports may cause the part to break:

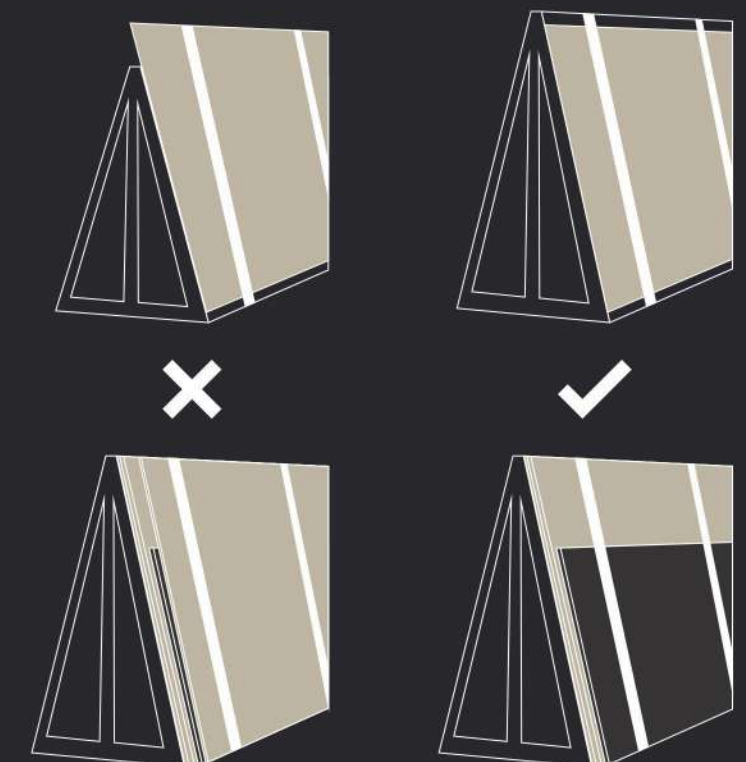

Avoid positioning large slabs against smaller slabs:

03.3 Laying & Fixing

The growth in popularity of large format tiles, with their increased weight and smoother backs, presents new fixing challenges to the professional tiler.

Correct preparation of the subfloor or laying surface is crucial. The laying surface should be rigid, non-flexing and capable of supporting the expected load with minimal or no deflection. A level subfloor is extremely important in order to keep tiles from cracking. Sanding high spots and the use of a levelling compound on low spots is essential. It is also important that TechnoSLAB are clean and dry, if necessary wash them with clean water and dry them thoroughly before fixing.

Whatever your specific requirements, whether they be for standard or large format TechnoSLAB within internal or external applications, selecting the appropriate cement-based, fibre-reinforced or ready-mixed adhesive is vital to ensuring the success of your project.

Once your subfloor is clean and dry, spread the adhesive on the surface to be covered with a 10x10mm square toothed trowel, covering an area 5cm to 10cm more than the size of the TechnoSLAB. Always apply the adhesive in stripes running parallel with the short edge to remove air pockets and bubbles. By using this method, full coverage of the TechnoSLAB with adhesive is ensured.

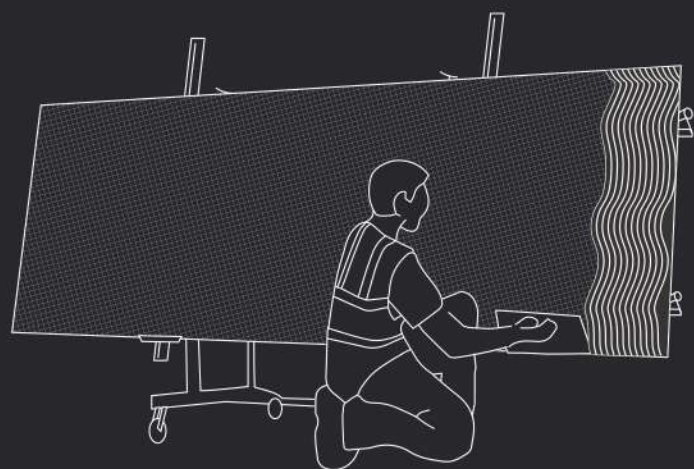
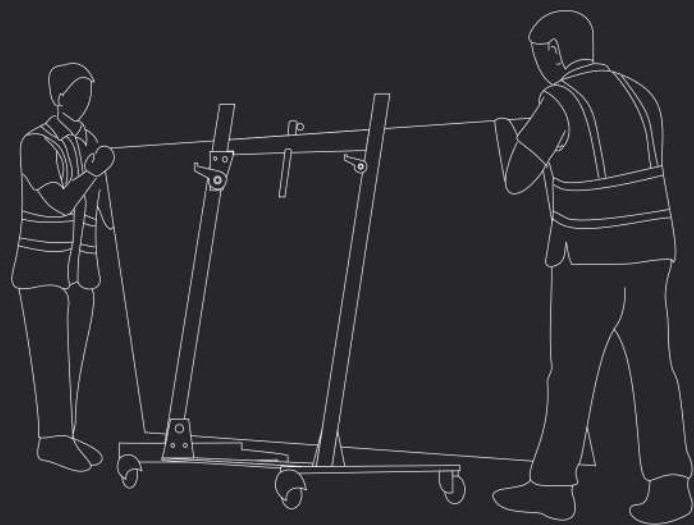
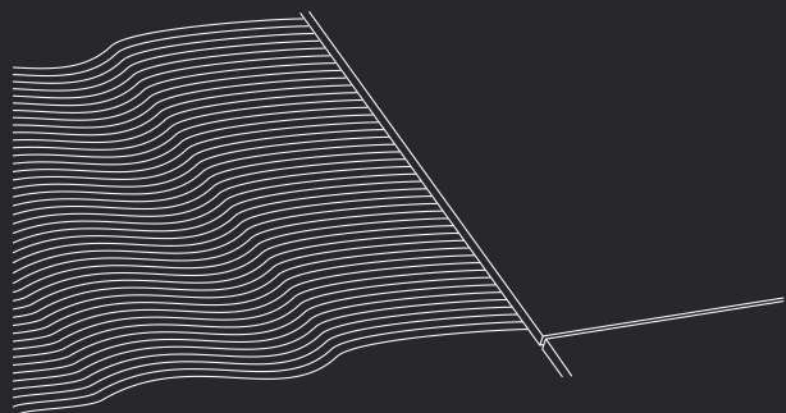
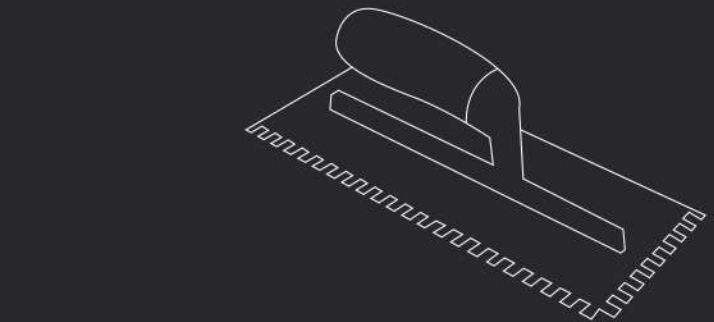

Large format TechnoSLAB always require back-buttering. Back-buttering describes the process of applying a layer of adhesive to the back of the tiles using a trowel.

Using a specialist wheeled transport cart, fix the large format slab in a vertical position on the handling frame with the use of suction cups. Use a 10x10mm square toothed trowel for applying your adhesive to the wall or floor and when back-buttering use a 3x3mm square toothed trowel for the back of the tile.

Using the handling frame with suction cups, bring the slab into a vertical position and slowly lower it to horizontal. The TechnoSLAB should be firmly pressed into the adhesive along a straight edge, collapsing all adhesive ridges. Use a levelling system to avoid lippage and frequently checks that your TechnoSLAB are even using a suitable box level. Levelling systems are available with 2mm 3mm and 5mm tile spacers.

Periodically check the tiles backs to make sure there is full contact between the adhesive and tile. If not apply additional adhesive to the tile or use a trowel with larger notches in your adhesive. As you are working wipe off excess mortar with a wet sponge.

03.4 Levelling

Tile levelling systems are now commonly used. With large-format TechnoSLAB, they are absolutely essential. Given the size of the TechnoSLAB and their slimline thickness, unless a levelling system is used, it will result in lippage.

After the first TechnoSLAB has been laid and levelled, before proceeding to lay the second one, insert levelling clips below the first (Fig. 2). Then lay the next TechnoSLAB and tap it to ensure a firm bond. Next, adjust the level (Fig. 3) of both TechnoSLABs by pushing the wedges into place with the levelling pliers (Fig. 1).

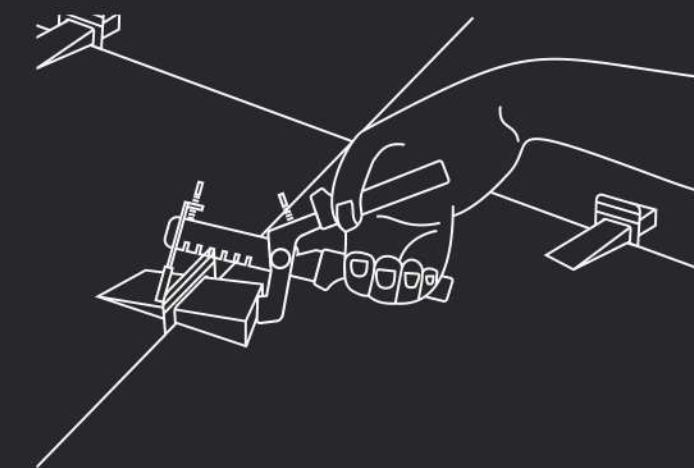
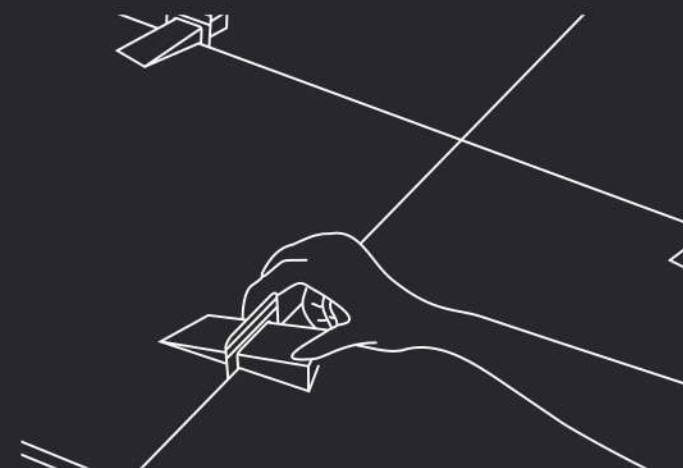
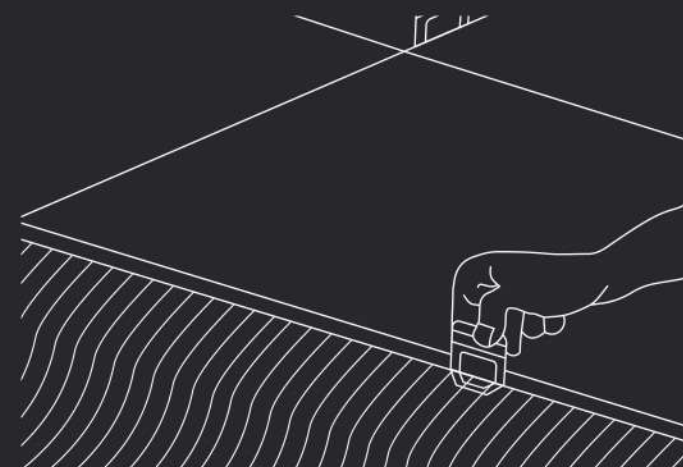
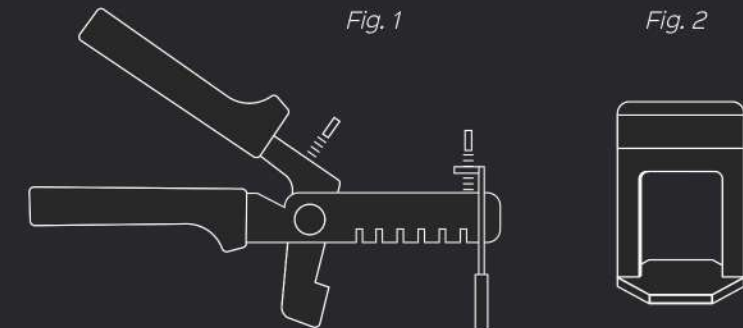

The contributing factors to what causes TechnoSLAB lippage are how much warpage the TechnoSLAB has, the width of the grout, how flat the substrate is, and the expertise of the tile installer. We recommend that lippage should not be greater than 2mm at the most for this type of installation.

In order to ensure a uniform surface and produce a surface with acceptable lippage, make use a levelling system to avoid lippage and frequently check that your TechnoSLAB are even using a suitable box level. Levelling systems are available with 2mm, 3mm and 5mm tile spacers.

03.5 Cutting

Mark the portion to be removed at the ends of the TechnoSLAB with a pencil. Position the cutting guide with cutting carriage so that the references on the guide coincide with the lines marked on the panels. Lock the cutting guide with the cutting carriage in place using the suction cups. To guarantee correct scoring, the pressure and movement of the cutting carriage must be constant along the whole length of the cut. Score one end of the panel by 15cm pushing the cutting carriage towards the edge of the panel. Complete the scoring up to the opposite end of the panel.

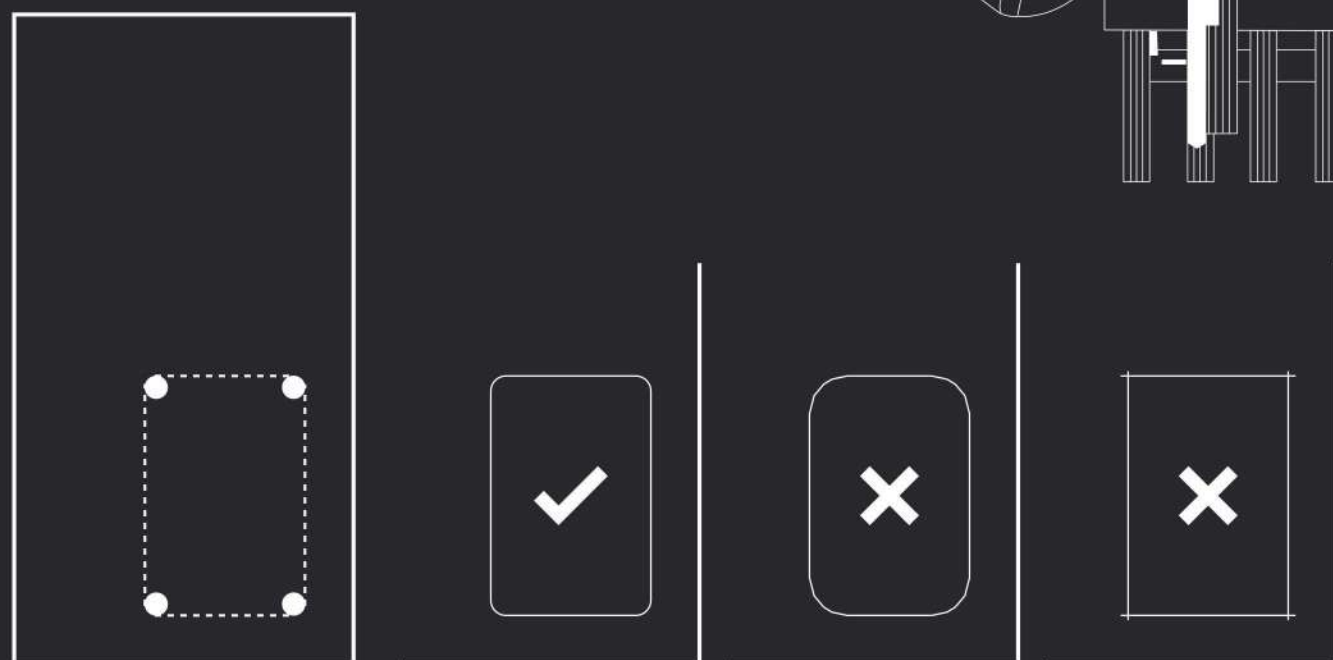
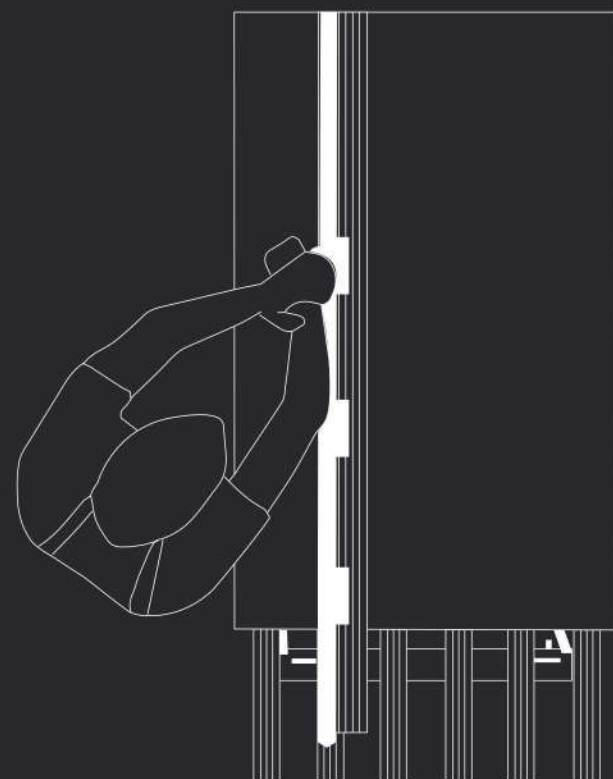

Prepare the holes on all inner corners, minimum 3mm bit diameter.

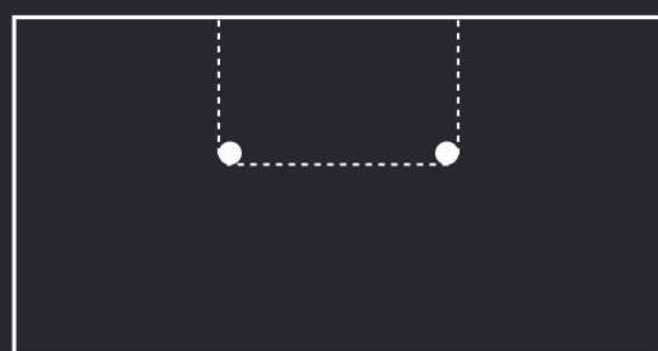

When cutting a "U" shaped piece, mark and drill relief holes where the cut lines intersect, always making the shortest cut first.

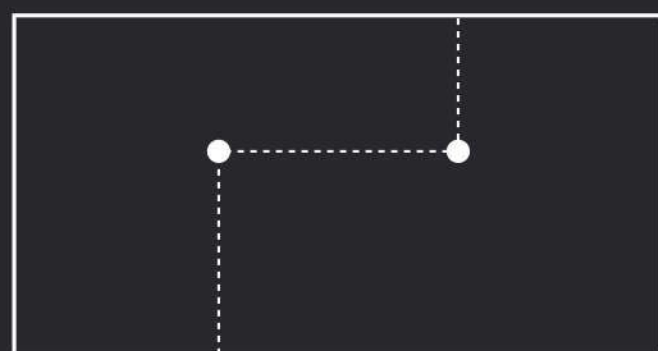

When cutting an "L" countertop, drill relief holes where the cut lines intersect, always making the shortest cut first.

03.6 Cleaning

03.6.1 Cleaning after laying

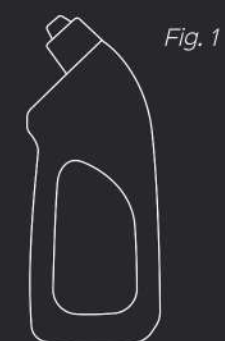

We suggest a good initial cleaning after the laying on the floor or wall, this is very important for removing residual grouting and the normal dirt coming from the building works.

We suggest the use of a cementitious descaler, that is a lightly acid product that doesn't emit fumes that are harmful for the user and that can attack joints. In case of material layed with epoxy or resinous grouting, we recommend to clean after laying with specific detergent.

03.6.2 Regular maintenance



For a good cleaning of the floor we suggest the use of a natural detergent with a high cleaning power. In case of strong dirty and encrusted by the time, we recommend to consult the following scheme to find the perfect solution to every situation

TYPE OF DIRT	PRODUCT
Cement, Kalkstein, metal tracer, rust	Cementitious descaler
Residuals, stains and halos of epoxy joints	Epoxy descaler
Grease, tire marks, colours, marker, etc.	Non soap degrease
Graffiti	Acetone and antigraffiti star

03.6.3 Recommendations

Drying process

Once the tiles have been grouted and any excess grout cleaned off, it is important to wait the stipulated time before using the tiled surface; in other words, any cleaning should wait until the tiled surface is completely dry. We recommend waiting 5 days before cleaning in readiness for full use.

Protection from liquid

The newly tiled surface must be protected from water and damp while the adhesive and grouting materials are maturing and hardening. This is particularly important in outside spaces and areas where there is a risk of freezing.

Damage Prevention

Measures should also be taken to protect the newly tiled surface against mechanical or chemical damage resulting from subsequent work by other professionals or later installations. Damage can be prevented by covering the floor tiles with thick cardboard or similar material.

Cleaning products

For the final cleaning of the tiled surface, the products used should be compatible with the chemical resistance of the tiles. Avoid solid detergents with abrasive particles and solutions containing hydrofluoric acid, which attacks the glaze and causes irreversible damage to the ceramic tile.

03.7 Technical specification

CHARACTERISTIC	TEST METHOD	MEAN VALUE OF	STD. AS PER ISO13006:2012/EN14411 Gr.Bla	STD. AS PER IS15622:2017 Gr.Bla
Regulatory Properties				
Deviation in length and width	ISO 10545-2 & IS 13630-1	± 0.10 %	± 0.50 %	± 0.10 %
Deviation in thickness	ISO 10545-2 & IS 13630-1	± 4.00 %	± 5.00 %	± 5.00 %
Straightness in side	ISO 10545-2 & IS 13630-1	± 0.10 %	± 0.50 %	± 0.10 %
Rectangularity	ISO 10545-2 & IS 13630-1	± 0.10 %	± 0.60 %	± 0.10%
Surface flatness Central Curvature	ISO 10545-2 & IS 13630-1	± 0.10 %	± 0.50 %	± 0.50 %
Surface flatness Edge Curvature	ISO 10545-2 & IS 13630-1	± 0.10 %	± 0.50 %	± 0.50 %
Surface flatness Warpage	ISO 10545-2 & IS 13630-1	± 0.10 %	± 0.50 %	± 0.50 %
Surface Quality	ISO 10545-2 & IS 13630-1	> 95% defects free	> 95% defects free	> 95% defects free
Small Color Difference	ISO 10545-16	No Change	Unaltered	N.A.
Glossiness (With Nano Polished)	Gloss Meter 60°	> 90° **	As per Mfg.	As per Mfg.
Glossiness (Without Polished)	Gloss Meter 60°	7° < Gloss < 14°**	As per Mfg.	As per Mfg.
Glossiness (Satin Finished)	Gloss Meter 60°	15° < Gloss < 25°**	As per Mfg.	As per Mfg.
Structural Properties				
Water absorption	ISO 10545-2 & IS 13630-3	≤ 0.50 %	≤ 0.50 %	≤ 0.80 %
Bulk density	DIN51082 & IS 13630-3	> 2.28 gm/cc	> 2.00 g/cc	Min. 2.20 g/cc
Massive Mechanical Properties				
Modulus of rupture	ISO 10545-4 & IS 13630-6	Min. 37.0 N/mm ²	Min. 35.0 N/mm ²	Min. 35.0 N/mm ²
Breaking strength thickness <7.5	ISO 10545-4 & IS 13630-6	Min. 1000.0 N	Min. 700.0 N	Min. 700.0 N
Breaking strength thickness ≥7.5	ISO 10545-4 & IS 13630-6	Min. 1600.0 N	Min. 1300.0 N	Min. 1100.0 N
Surface Mechanical Properties				
MOH'S hardness	EN 101 & IS 13630-13	Min. 4***	Min. 4	Min. 5
Surface abrasion resistance-Glossy #	ISO 10545-7 & IS 13630-11	Min. Class 2	As per Mfg.	Min. Class II
Surface abrasion resistance-Matt #	ISO 10545-7 & IS 13630-11	Min. Class 3	As per Mfg.	Min. Class II
Thermal Hydrometric Properties				
Moisture expansion	ISO 10545-10 & IS 13630-3	NIL	Max. 0.06	Max. 0.02
Thermal expansion(COE) at 100°C	ISO 10545-8 & IS 13630-4	Max. 6.0 x 10 ⁻⁶	As per Mfg.	Max. 7.0 x 10 ⁻⁶
Thermal shock resistance	ISO 10545-9 & IS 13630-5	Min. 10 Cycle	Min. 10 Cycle	Min. 10 Cycle
Crazing Resistance at 7.5 Bar	ISO10545-11 & IS 13630-9	Min. 6 Cycle	As per Mfg.	Min. 4 Cycle
Impact resistance(COR)	ISO 10545-5 & IS 13630-14	Min. 0.55	As per Mfg.	Min. 0.55
Frost resistance	ISO10545-12 & IS 13630-10	Frost Proof	As per Mfg.	As per Mfg.
Chemical Properties				
**Resistance to Staining Glazed	ISO 10545-14 & IS 13630-8	Min. Class 4 / Min. Class I	Min. Class 3	Min. Class I
**Resistance to Household Chemicals & Swimming Pool Salts Glazed	ISO 10545-13 & IS 13630-8	Min. Class GA / Min. Class AA	Min. Class GB	Min. Class AA
Resistance to Low / High Concentrate Acid and Alkalis Glazed	ISO 10545-13 & IS 13630-8	Min. Class GLB** / Min. Class A****	As per Mfg.	As per Mfg.
Safety Properties				
Skid resistance(DCOF-DRY)	ISO 10545-17	> 0.40	As per Mfg.	As per Mfg.
Slip resistance(DCOF)(R value)##	ISO 10545-17	N.A.	As per Mfg.	As per Mfg.
Determination of Lead & Cadmium Release for Glazed Tiles	ISO 10545-15	Dose not yield Pb & Cd	As per Mfg.	N.A.
Fire Resistance	N.A.	Fire Proof	As per Mfg.	As per Mfg.

Glaze tiles Intended for use on floor
 ## As per customer requirement
 ** Glossiness 90% with nano technology
 *** Without nano technology (Unpolished Vitrified tiles)
 **** Except Hydrofluoric Acid & It's compound

03.8 Container packing details

Size	Thickness	Weight /Slab	No. of Bundles or A-Frames	Total Slabs or Box	Slabs / Container	sq mtr / Container	Weight/ Container	Size of Container
** 3200x1600mm	6mm	73.5 kg	7	40 slabs	280	1433.60	21.5 t	20 ft
## 3200x1600mm	6mm	73.5 kg	3	40 slabs	120	614.40	9.82 t	20 ft
## 3200x1600mm	6mm	73.5 kg	9	40 slabs	360	1843.20	27.6 t	40 ft
** 3200x1600mm	9mm	110.0 kg	7	26 slabs	182	931.84	20.2 t	20 ft
## 3200x1600mm	9mm	110.0 kg	9	26 slabs	234	1198.08	25.7 t	40 ft
** 3200x1600mm	12mm	147.0 kg	7	20 slabs	140	716.80	21.5 t	20 ft
## 3200x1600mm	12mm	147.0 kg	3	20 slabs	60	307.20	9.8 t	20 ft
## 3200x1600mm	12mm	147.0 kg	9	20 slabs	180	921.60	27.4 t	40 ft
* + # 2400x1200mm	6mm	41.5 kg	8' + 4"	56' + 24"	544	1566.72	23.0 t	20 ft
## 2400x1200mm	6mm	41.5 kg	4	40 box	320	921.60	14.0 t	20 ft
# 2400x1200mm	6mm	41.5 kg	12	24 slabs	288	829.40	13.1 t	20 ft
* 2400x1200mm	6mm	41.5 kg	11' + 1'	56' + 24'	640	1843.20	27.0 t	40 ft
## 2400x1200mm	6mm	41.5 kg	8	80 slabs	640	1843.20	27.0 t	40 ft
# 2400x1200mm	6mm	41.5 kg	24	24 slabs	576	1658.90	26.3 t	40 ft
* + # 2400x1200mm	9mm	62 kg	8' + 4"	34' + 16"	336	967.68	21.4 t	20 ft
## 2400x1200mm	9mm	62 kg	4	50 box	200	576.00	12.8 t	20 ft
# 2400x1200mm	9mm	62 kg	12	16 slabs	192	552.90	13.1 t	20 ft
* 2400x1200mm	9mm	62 kg	12' + 1'	34' + 12' box	420	1209.6	26.5 t	40 ft
## 2400x1200mm	9mm	62 kg	8	50 box	400	1152.00	25.4 t	40 ft
# 2400x1200mm	9mm	62 kg	24	16 slabs	384	1105.90	26.2 t	40 ft
## 1600x1600mm	9mm	55 kg	6	48 slabs	288	737.28	17.0 t	20 ft
## 1600x1600mm	9mm	55 kg	11	48 slabs	528	1351.68	27.2 t	40 ft
* + # 1200x1200mm	9mm	62 kg	13' + 4"	26' + 21"	422	1215.36	27.0 t	20 ft
# 1200x1200mm	9mm	62 kg	17	26 slabs	422	1215.36	27.0 t	40 ft

** = Bundle | * = Vertical Pallet | ## = A-Frame | # = Horizontal Crate

Note:

- Horizontal Crates: Slabs will be available without box packing for horizontal crates.
- 3200x1600mm: will be available without box packing only.
- 2400x1200mm: 6mm thickness slabs available in 2 pcs box packing & 9mm thickness slabs available in 1 pcs box packing.
- 1600x1600mm: 9mm thickness slabs available in 1 pcs box packing.
- 1200x1200mm: 9mm thickness slabs available in 2 pcs box packing.

